

Nine Main Points for the Synthesis of Electricity

There are nine major points, or *tricks of the trade*, for synthesizing electricity from the aether...¹

1. **One common oversight is to overlook feeding the circuit a precharged capacitance equivalent to the background voltage in the environment** – which just happens to be the same level of power used by crystal radios of the 1920s – *a few micro volts*. In this example, I charge $3\mu\text{V}$ at capacitor, C4.

(a) This is what trees are designed (ie, expected) to absorb, because trees make the best aerials if you connect them to your AM radio via a bare iron nail driven through their bark reaching into their sap. They don't have to have any leaves on them. But they must be alive with sap to make a solid conductive connection to their entire shape which just happens to be the same shape used by TV antennas of a bygone era. These odd shapes perched (such as they were) on the roofs of homes, used to dot the landscape of western civilization before broadcasters converted to digital their transmission of signals replacing their former use of analog. Now, we use WiFi to connect to cost-free channels of television broadcast.

(b) **Voltage regulation emanates from voltage sources**. This is analogous to point #3 (below) in that dielectric lines of force arise from voltage sources. This has a direct impact on the behavior of each and every component in a circuit.

i. This is due to each dielectric line of force is a direct connection between the two end-points of each line of dielectric force.

ii. One end-point of each line of dielectric force terminates on the voltage source. The other end-point (of each line of dielectric force) terminates on a component of a circuit.

iii. There are multiple lines of dielectric force “reaching out” towards each component from a voltage source.

A. One type of outreach is called, “voltage drop”. This is a rudimentary example of how dielectric lines of force interact with the components of a circuit (any circuit: overunity or conventional). Voltage drop is a rudimentary example, because it does not spawn any reactance among the components at either end of each dielectric line of force.

¹ Franco Bruno Corteletti's answer on Quora to, “What the aether is?” – <https://qr.ae/pGczV8>

- B. Another type of outreach is *not* a one-way (direct current) analysis. It is the **complex interaction among all reactive components of a circuit** between: voltage sources (if there are any voltage sources in use) and capacitors or inductors or the environment, etc.
- iv. Eliminate a circuit's dependency upon externalized voltage sources to allow infinity to manifest within your *wannabe*, overunity, free energy circuit.
 - v. Voltage sources, ie. batteries, etc, would serve a much better use as *patio sculptures* rather than as fixtures in our lives. ;-)
2. The precharged voltage on capacitor, C4, is merely serving as a stimulant (ie, catalyst) to initiate oscillations.
- (a) These oscillations, initiated at C4, will be supported by the 100 femto capacitances of C4 and C2.
 - (b) We have effectively split up the function of a time-variant, voltage source by sending out signals from capacitors, C4 and C2, while amplifying their output through inductor, L1.
 - (c) These pair of capacitors flank each side of the magnetic transference of power originating from inductor, L3 and migrating towards inductor, L5, effectively protecting both inductors from loss of voltage which could have leaked out to ground, from C4, or leaked to inductor, L1, from C2. C2 also stabilizes the calculations of LTSPICE making them less prone to variations resulting from the user choosing different durations for transient analysis.
3. It is significant that *the connection between the L1 subcircuit loop and the L3 subcircuit loop* (containing the pair of 100 femto capacitances) is an **electrostatic coupling** due to it being a **single wire connection**. So, only voltage can get through (unlike a transformer coupling in which only current can get through). Each loop manifests its own current – especially, loop L5 manifesting extremely high levels of current versus its voltage due to its use of a magnetic coupling. Inductor, L5, eventually, achieves a zero status of volts and an infinite amount of current indicating zero impedance.
4. Because of point #3, **Energy is NOT being extracted from the air, nor from the ground, to power this type of circuit.**
- (a) Yet, **energy can be extracted from nearby sources without any theoretical limit due to very strong lines of dielectric force emanating from this type of circuit.** So, beware of locating

your “free energy” device within range of transmission lines. For, these lines will become a source of free energy to the detriment of whatever conventional source of voltage is empowering these lines.

- (b) If there are no transmission lines nearby, then this type of circuit will synthesize its own reactive power from the *counter-space* of space. This “other world” of electrodynamic theory is popularly referred to as *the aether* and conventionally – and mathematically – referred to as the *complex field of numbers* predicated upon the square root of negative one.

5. Segregation of extremely different ratios of impedance...

- (a) Another major bullet point is to segregate the circuit into one section which specializes in accumulating *high voltage versus low current*. This will replace the need for a voltage source while allowing for the escalation of frequency (which is vital for the synthesis of electricity to occur). This will be an area of high impedance.
- (b) Another section of this type of circuit encourages the accumulation of *high current versus low voltage* (loop L5 depicted in the LTSPICE circuit example, below). This will be an area of low impedance. And if this just happens to be the inductive load of the circuit, then all the better!
- (c) Tesla Motors encourages a current to flow through the rotor coil of their motor which is significantly elevated above its voltage (if we consider the ratio between the units of current versus the units of voltage).
- (d) The power supply of Sangulani Maxwell Chikumbutso also exhibits a low impedance of about 100mΩ. This low impedance favors the performance characteristics of race cars.
- (e) Alan Cocconi² figured this out when he designed the motor controller for the General Motors EV-1 (see, “Who Killed the Electric Car”),³ and this feature was included in his hobby of designing, building and racing electric cars. He is also a silent partner behind Elon Musk, for he contributed the motor controller from the EV-1 toward the development of the first car produced by Tesla Motors, the Roadster.

6. All of this excessive energy needs to be stored somewhere. The circuit responds by increasing

2 Search for “Alan Cocconi AC Propulsion” – <https://is.gd/ixesix> = <https://duckduckgo.com/?q=alan+cocconi+ac+propulsion&t=iphone&ia=web>

3 Search for “Who Killed the Electric Car” – <https://is.gd/unekaf> = <https://duckduckgo.com/?q=who+killed+the+electric+car&t=iphone&ia=web>

its frequency of oscillations to accommodate a smaller and smaller unit of time per cycle. This increase of frequency stores more power per unit of time by compressing each cycle (within any arbitrary unit of time which we may choose to use to make these comparisons). This escalation of frequency can only be possible if we throw away our conventional sources of voltage and resort to reactive techniques.

7. So... No law of physics has been violated. We've simply and economically used a limited resource using a method that meets or exceeds our obligation for power and have eliminated power as a continuing expense. Power is, now, transferred to the upfront cost of our appliances rather than stretched out over our entire lifespan!

(a) We have forgotten how useful is the dielectric force, of the single-wire connection, for coupling inductors and isolating their magnetizing current from other inductors. We have, unfortunately, been misled to believe that the magnetic transference of power across transformer couplings is the only way to isolate various subcircuits from each other. *Thank you, Bedini,⁴ Tesla, and Eric⁵ for promoting this concept.*

(b) *Energy* is not a mass, nor is it derived from mass. It is *the excitation of mass*.

(c) Electricity is derived from the valence electrons of atomic matter.

(d) Resistance is derived from the mass of atomic matter.

(e) Reactance is a byproduct of time.

(f) If we can keep these disparate concepts clearly separated in our head, then we will have made a great deal of progress in our discernment of electrodynamic theory and its application.

(g) The theory of electrodynamics supports infinite growth regardless of any physical limitation, or our own ignorance, which may get in its way.

8. Now, why on Earth is it so important that an infinite quantity of energy be available? What could we possibly use it for?...UFOs!

(a) If you've got an electric motor, then you can expect to regain the reactive power that was sent to energize its coils once you shut OFF the motor. But a UFO does not have any coils to energize and rotate. A UFO has to energize its immediate surroundings in order to neutralize

4 <http://johnbedini.net/>

5 <http://ericpdollard.com/>

inertia to be able to make those right-angle turns while doing 4k+ mph. It also has to emit a very strong electrostatic field to serve as a backdrop to give safe harbor to its emission of electromagnetics so that the EM emission won't go to waste by quickly dissipating. So, the electrostatic field substitutes for the coils of a motor and protects the EM field inside itself. All of this takes a huge amount of energy which will not be available for returning it back to whatever source of energy is powering this thing, so you'd better be prepared to waste lots of energy...energy that you must synthesize for free and in abundant quantity.

(b) In order to levitate, we have to disorganize gravity. Gravity is an organization of energy much like a magnetized piece of steel becomes a permanent magnet despite its former existence as a magnetically disorganized piece of steel.

i. Paramagnetism does more than merely export magnetism out of aluminum or any other paramagnetic material. Paramagnetism also disorganizes magnetism by scattering it. It does this by its parallel property of being highly reflective. This is why aluminum is used in radar antennas. Because it is highly reflective and can effectively scatter outgoing waves.

ii. If we were to use iron anywhere within a UFO craft, the iron would concentrate magnetic force and organize that force inside of itself. This is why we use iron as the material for the core of transformers. But this is not safe if we should supercharge this iron with abundant free energy, for this would quickly cause the iron to heat up and explosively destroy whatever circuit is attached to it. So, we *must* use a paramagnetic material instead of using a ferromagnetic material throughout the construction of the entire circuitry of a UFO craft in addition to the whole structure of the craft and the clothing of its occupants should also be paramagnetic.

iii. This is what this circuit is useful for....powering a UFO.

9. To quote a great man...

(a) "Today's science fiction is tomorrow's science fact." – Isaac Asimov.

(b) But this cuts both ways (*shastra* = Sanskrit noun = science; scripture; two-edged sword).

(c) My science fact is somebody else's science fiction.

(d) *By way of analogous parallelism...*⁶ "Knowledge is structured in consciousness. Knowledge

⁶ Maharishi's Vedic Science – <https://is.gd/vopiya> = <http://www.jadrankomiklec.com/en/science-and-traditional-knowledge-of-life/vedic-science/maharishi%E2%80%99s-vedic-science-veda-and-vedic-literature.html>

is different in different states of consciousness. He whose awareness is not open to this reality, what can these eternal expressions of knowledge accomplish for him? Yet, he whose awareness is open to it, is firmly and profoundly established in it.” = Richo akshare parame vyoman. Yasmin deva adhi vishve nishedhuh. Yasthanna veda kimricha karishyati. Ya ittadvidusta ime samasate. – Rig Veda I.164.39

(e) “These expressions of knowledge seek out he who is awake.” = Yo jagara tam richah kamayante – Rig Veda V.44.14

(f) “Transcend” = Nivartadhvam – Rig Veda X.19.1

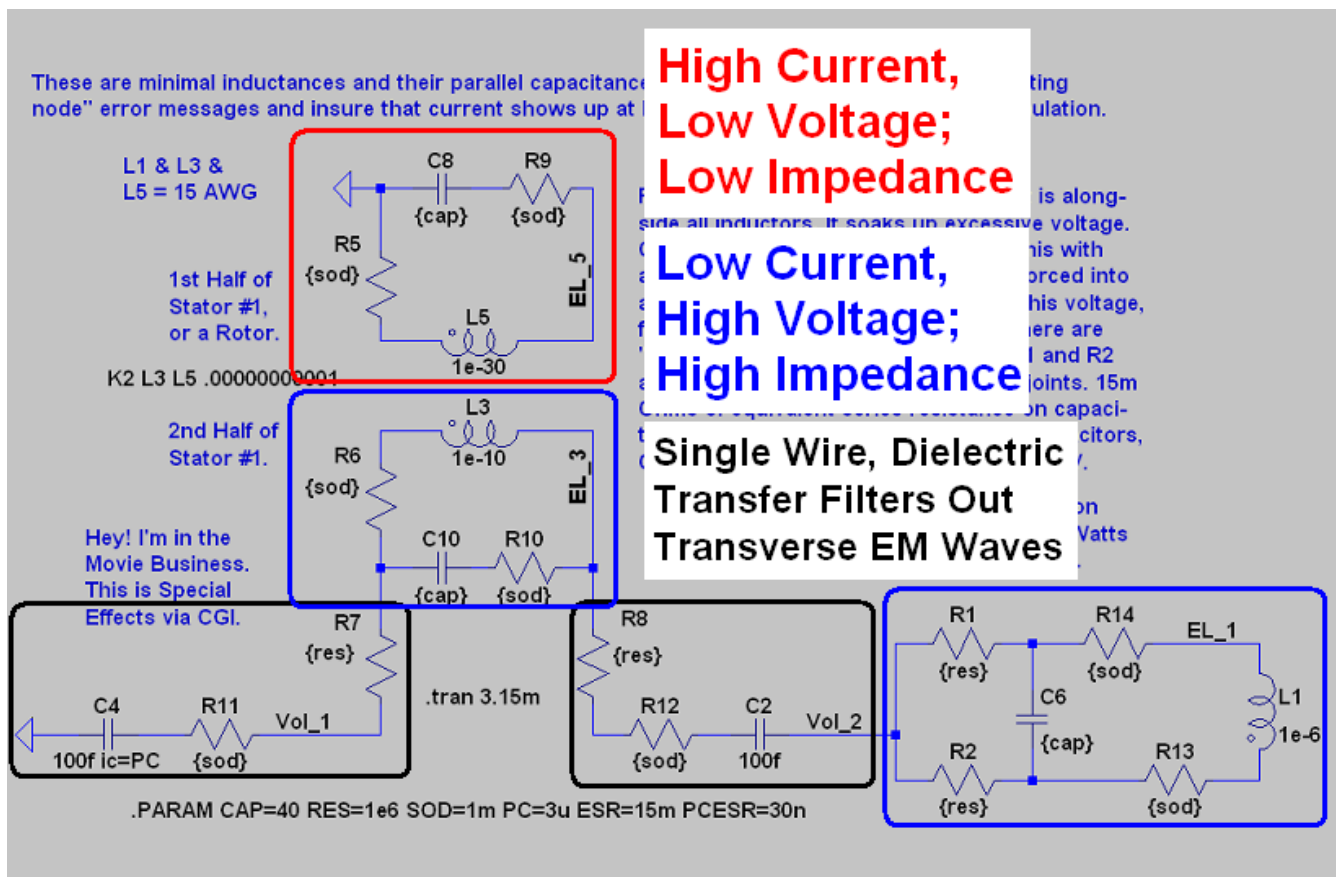

Schematic ↑ above ↑ and ↓ below ↓

These are minimal inductances and their parallel capacitances to avoid "singular matrix" and "floating node" error messages and insure that current shows up at L5 within a reasonable duration of simulation.

L1 & L3 &
L5 = 15 AWG

1st Half of
Stator #1,
or a Rotor.

K2 L3 L5 .000000000001

2nd Half of
Stator #1.

Hey! I'm in the
Movie Business.
This is Special
Effects via CGI.

Parallel capacitance is phenomenal if it is alongside all inductors. It soaks up excessive voltage. Coils do not need to be subjected to this with any expectation of their having to be forced into a situation in which they MUST store this voltage, for this gives an error message that there are "floating nodes". Resistors, R7, R8, R1 and R2 are safety fuses. All others are solder joints. 15m Ohms of equivalent series resistance on capacitors, C2 and C4. 30n Ohms of ESR on capacitors, C6, C8 & C10. No fatal errors in LTSPICE IV.

Alternation of Consumption and Generation of Watts at L1. Consumption of Positive Watts at L3. Generation of Negative Watts at L5.

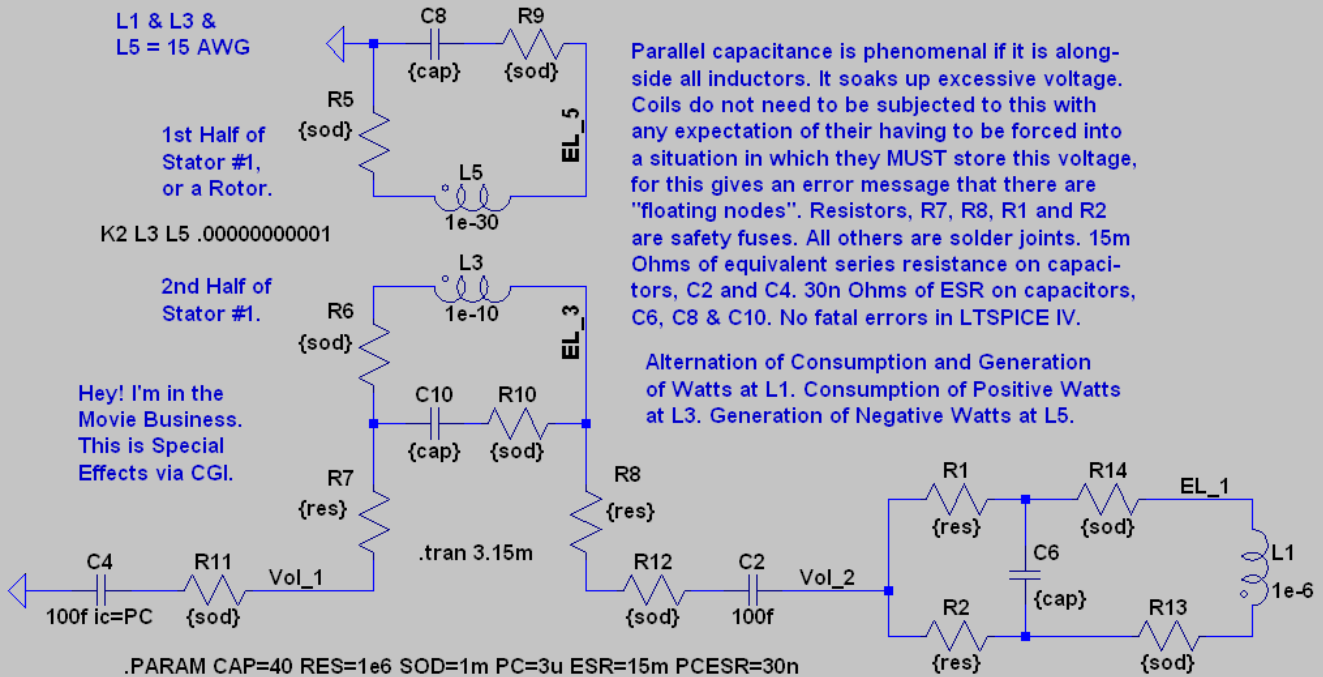

The internalized series resistance for each coil is one-tenth of its inductance (in Henrys).

This is what happens to current whenever impedance is zero (using normal inductances and a normal coupling coefficient) yielding super-conductance at room temperature at inductor, L5...

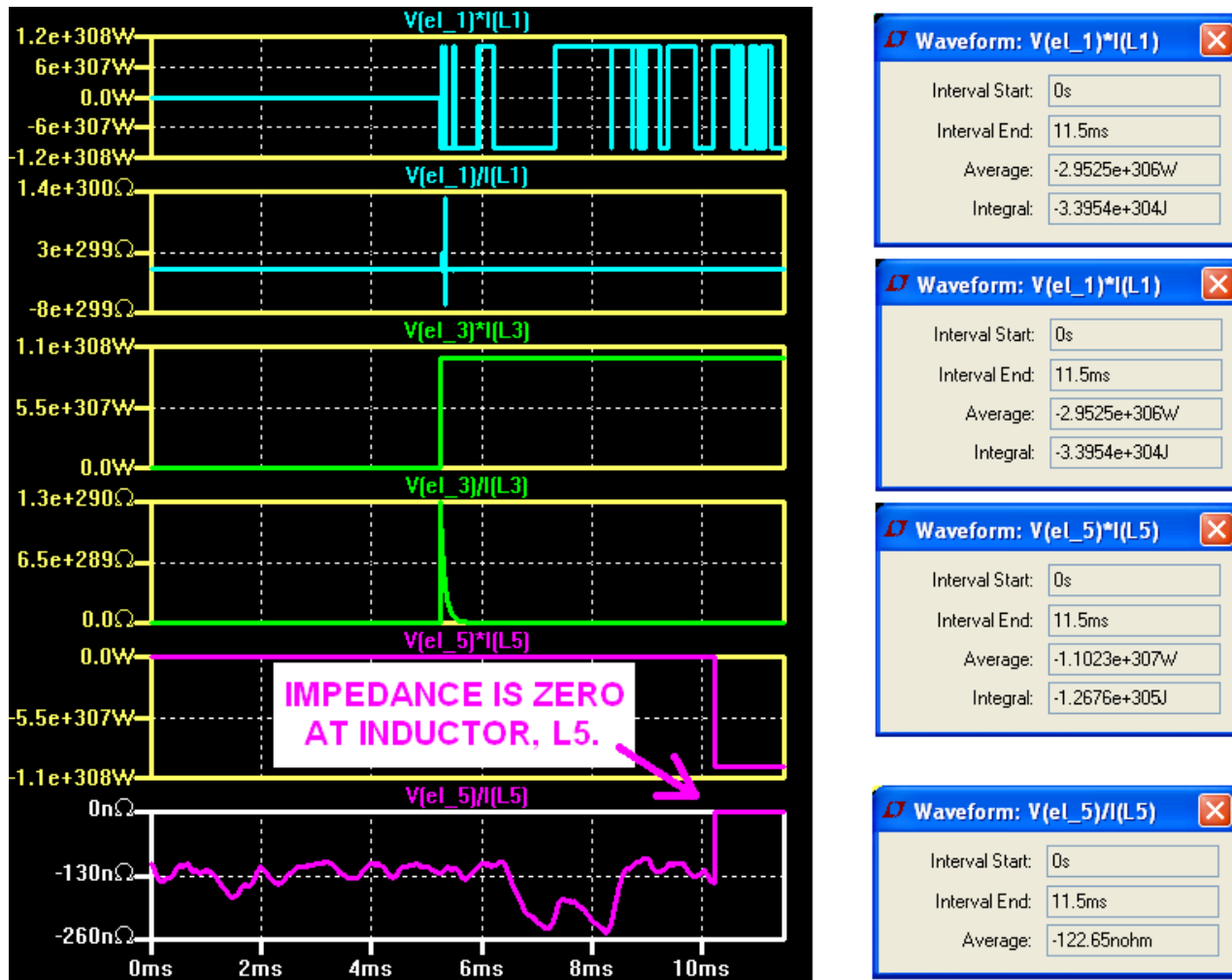

Current is in excess to voltage by the ratio of INFINITY to ONE at inductor, L5. This is what can happen whenever a circuit is governed by negative current whose polarity is the opposite of its polarity of voltage comprising its power. Current, here, is no longer traveling from areas of high voltage towards areas of lower voltage to equalize their differences. Instead, current is traveling from areas of lower voltage towards areas of higher voltage. This creates a condition of negative watts which just happens to be the passive sign conventional definition of the generation of power! So, we have taken standard measuring conventions and have used them to define how an overunity circuit must behave if it is to synthesize electricity in any amount which we desire.

Here are the default settings for LTSPICE IV in which this circuit was simulated...

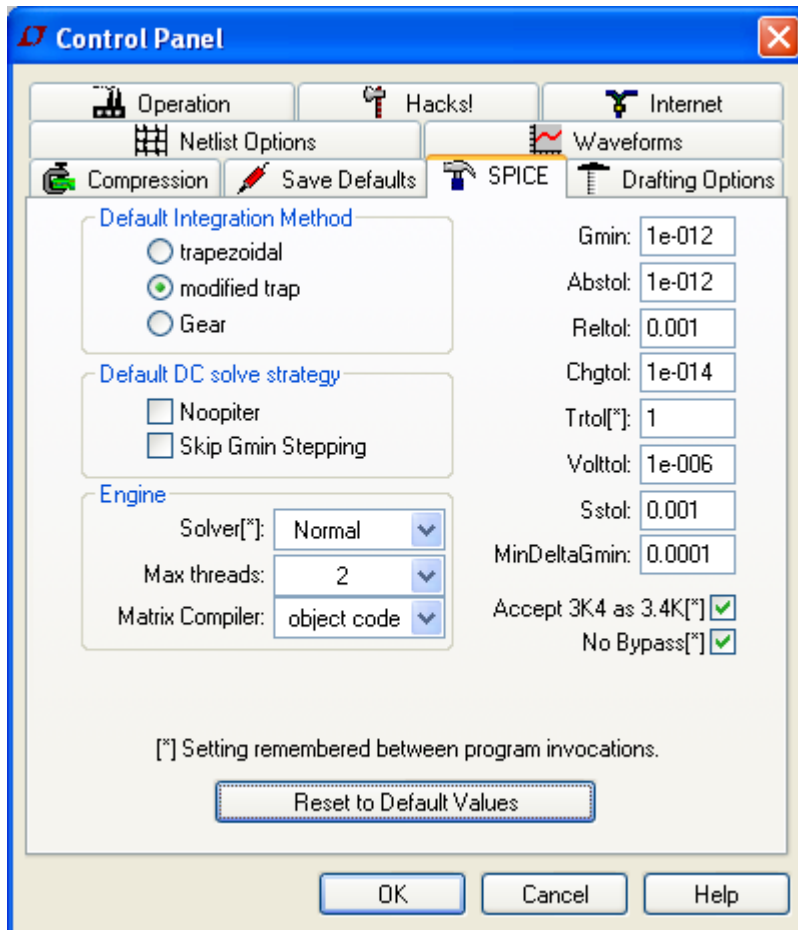

The Vertical Axes for V(e1_3) and I(L3) are Infinity! In fact, all of the axes are Infinity.

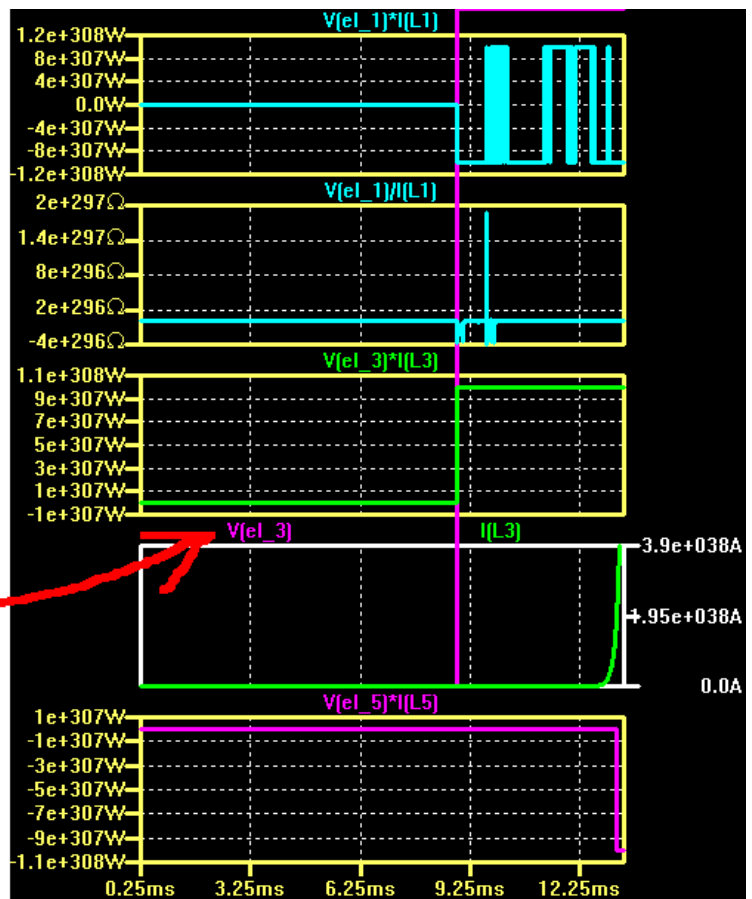
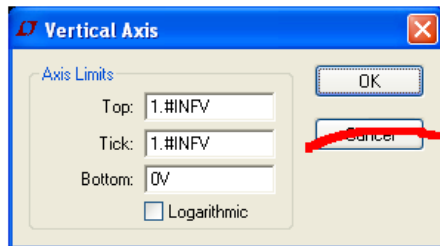

Forgetting how unrealistic are these INFINITE results, this shows how efficient this circuit is in avoiding fatal error messages – at any point during its simulation – which indicates how elegant is this circuit functioning as an archetype representing all that is the best of what overunity can be.

Here are the wattage outputs, plus their impedances, at the three coils of L1, L3 and L5 for the schematic, up above, which possesses minimalistic inductances...

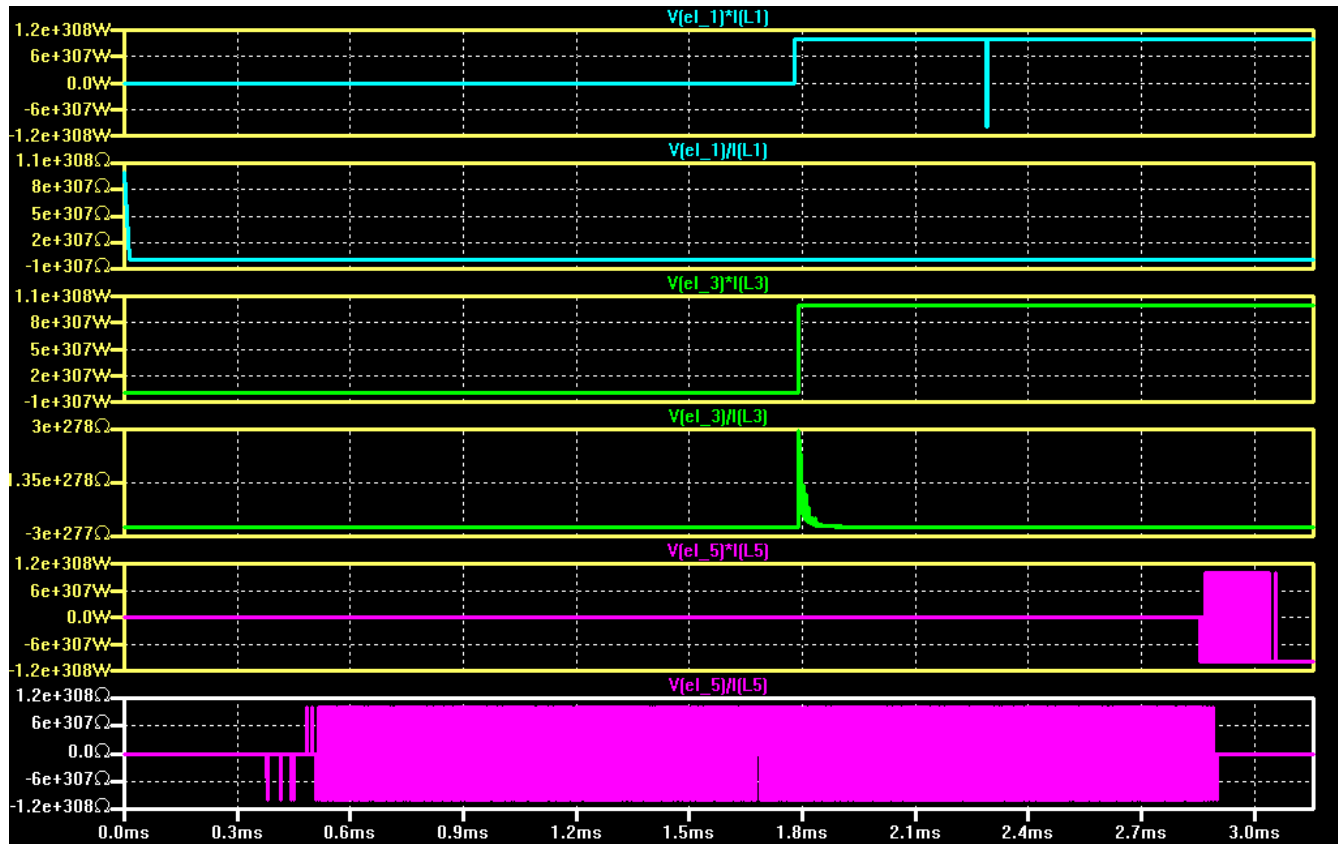

This minimalism shows how resonance does not figure into determining this circuit's efficiency. This is what I mean by an archetypal circuit is not limited to its fine tuning of parameters to achieve a state of resonance. Instead, an archetypal arrangement of components, plus minimum values (or greater) for some components and maximum values (or lesser) for other components, is more important than trying to achieve precise parametric values among these components.

This is the magic of adding very large resistances (courtesy of Mho's Law – the multiplicative and additive reciprocals of Ohm's Law), in select locations of this circuit, of 1 kilo or 1 Mega or 100 Mega Ohms (or more?...depending on the simulator). It shortens the time it takes to reach an infinite gain with the caveat of making the low impedance output of inductor, L5, unstable.

It also makes possible the severe reduction of inductance, and a mild reduction of capacitance, required to achieve explosive overunity.

Using variable capacitances for C6 and C10 is one candidate for throttling the rate of escalation of amplitude. It *may be possible* to match this against the rate of consumption of power at the inductive loads of L3 and L5? This may also be a safe way of turning this circuit ON versus OFF?

What sort of circuit does not require a relatively high coupling coefficient between a pair of coils for maximum efficiency? Answer...the power supply for a UFO in which there won't be much coupling between its coils since they won't be spaced close together and they'll be exporting their energy outside a UFO craft using the paramagnetism of aluminum.



You know your circuit is pretty good if it works equally well in one simulator versus another.

Berkeley SPICE is extremely popular. It has spawned so many variations that it is hard to find another simulator which is not based on it.

Paul Falstad's simulator⁷ is very unique and qualifies as a second opinion.

This circuit works equally as well in his simulator.

First, let's make a mild comparison with a slightly similar circuit which uses one module, of Eric Dollard's LMD analog computer (Longitudinal Magneto-Dielectric). Both of these two types of circuits share parametric excitation in common with each other. And both are using a single-wire connection for their momentary input to prevent the input of transverse electromagnetic waves and allow the input of longitudinal magneto-dielectric waves. But mine is encouraging the transverse electromagnetic force inside of each constrained loop of inductors, L1 and L3 and L5, dielectrically and magnetically linked among its three inductive loops. This is why it's so easy to simulate giving very smooth hyperbolic escalations towards infinity whenever simulated within LTSPICE...

⁷ <http://falstad.com/circuit/>

Here is Eric's LMD analog computer...

The screenshot shows a web browser window with a circuit simulator. The browser address bar contains the URL <https://is.gd/whatduh>. The simulator interface includes a menu bar (File, Edit, View, History, Bookmarks, Tools, Help), a toolbar with various icons, and a main workspace. The workspace displays a circuit diagram with a 1 μ V source, a 1k resistor, a 1F capacitor, and a 100 resistor. The circuit is connected to a 1k load. The text "Is this realistic?" and "Infinite Energy from an Open Path Input?" is overlaid on the diagram. The simulation controls on the right include "Reset", "RUN / Stop", "Simulation Speed", "Current Speed", and "Power Brightness" sliders. A "Current Circuit:" section is visible, containing the text "Pure Resonance" and a paragraph: "The oscillating electrical surge is the divergent source of negative resistance behind lightning capable of massive discharges whose limits are infinity. We're fortunate they never get that far!". Below the circuit diagram is a graph showing power (W) over time (s). The graph shows a sharp peak at $t = 140.93$ Cs with a time step of 10 Ms. The y-axis is labeled "1648645.16 YW capacitor, 1 F" and the x-axis is labeled "0 W".

Is this realistic?
<https://is.gd/whatduh>

1 μ V
+0 V

1k

1F

100

100

1F

1k

Infinite Energy from an Open Path Input?

1648645.16 YW
capacitor, 1 F

0 W

t = 140.93 Cs
time step = 10 Ms

Reset RUN / Stop

Simulation Speed

Current Speed

Power Brightness

Current Circuit:

Pure Resonance

The oscillating electrical surge is the divergent source of negative resistance behind lightning capable of massive discharges whose limits are infinity. We're fortunate they never get that far!

[Real-World Simulations](#)
[Overunity w/Series Resist](#)
[Step thru Simulations](#)
[Download the Circuits](#)
[Help](#) [Compare](#) [sTtT](#)
[Heavenly](#) [Divine](#) [Angels](#)

<https://is.gd/whatduh>

Here are two examples of my circuit...

potentiometer
Vd = 0 V
R1 = 232.7 mΩ
R2 = 767.3 mΩ
I1 = 1.64 A
I2 = 21.53 A

Click the switch for more power!
Is this realistic? <https://is.gd/watdah>

115.11 TV
capacitor, 1 μF

48.94 TV
capacitor, 1 μF

t = 29.67 Gs
time step = 2 Ms

-12.51 GV

-48.93 TV

Pure Resonance

The oscillating electrical surge is the divergent source of negative resistance behind lightning capable of massive discharges whose limits are infinity. We're fortunate they never get that far!

[Real-World Simulations](#)
[Overunity w/Series Resist](#)
[Step thru Simulations](#)
[Download the Circuits](#)

<https://is.gd/watdah>

The screenshot shows a circuit simulator window with a circuit diagram. The circuit includes a transformer (2H, 1:1, 60% C. Coef.), a 10kF capacitor, a 1μV source, several 100M resistors, a 1μF capacitor, a 206.000001μH inductor, and a 206μH inductor. The text "Is this realistic?" is overlaid on the circuit, along with the URL "https://is.gd/watdoh". The simulator interface includes a menu bar (File, Edit, View, History, Bookmarks, Tools, Help), a toolbar, and a status bar. The status bar shows "796.31 kV capacitor, 10 kF", "7.96 GV resistor, 1 Ω", and "t = 229.72 Gs time step = 2 Ms". A text box on the right contains the following text:

Pure Resonance
 The oscillating electrical surge is the divergent source of negative resistance behind lightning capable of massive discharges whose limits are infinity. We're fortunate they never get that far!

Real-World Simulations
 Overunity w/ Series Resistor
 Step thru Simulations
 Download the Circuitry
 Help Compare sTtTs
 Heavenly Divine Angels

<https://is.gd/watdoh>

This presentation is available as a PDF file at...

http://vinyasi.info/mhoslaw/WoW_Parallel_Capacitance/Nine Main Points_.pdf

Its shortcut URL is...

<https://is.gd/vubiqu>

It is also posted on Quora in the "Electrical Science" space...

<https://qr.ae/pGczQS> or... <https://is.gd/itumag>

Its circuit file and screenshots are ZIPPED up at...

<https://ufile.io/t64k2rcu> and...

http://vinyasi.info/mhoslaw/WoW_Parallel_Capacitance.zip