

Nothing is too wonderful to be true if it be consistent with the laws of nature,

and in such things as these, experiment is the best test of such consistency.



The Limited Domain of Michael Faraday's Law of Induction merely applies to the Conservation of Energy.

Does Michael Faraday's Law of Induction concern itself with the conversion (consumption / conservation) of alternating (A/C) power or with the generation of alternating power?

I think it is the former. The latter condition of the synthesis (generation) of power is a standing wave which cannot dissipate, ie. it cannot exit the circuit as: heat, or light, or mechanical motion of a coil unless it is first converted. But for this conversion to occur, it can no longer exhibit a standing wave pattern in which its phase of voltage and its phase of current are diametrically opposed in polarity (with 180° of separation between them). Instead, in order for conversion to occur, it must realign the phase polarities of its voltage and current to exhibit a maximum power factor to manifest, and maximize, the output of this conversion of power. Otherwise, the standing wave pattern will force a constant build up of reactive power which will, eventually, destroy the circuit which hosts this condition.

Hence, Michael Faraday's Law of Induction is a narrow niche, for it merely defines the consumption of power while ignoring its generation.

Energy is always moving, ie. undergoing changes, but standing waves of energy do not move. Their energy moves, yet their wave pattern does not move.

It is only a moving wave pattern which can be conserved. Everybody is so focused on the conservation of energy while ignoring the non-conservation of their standing waves. For, it is their patterns, not their energy, which defines the consumption or the generation of power.

Here is the data in the format of screenshots of the simulation of a circuit in Micro-Cap – which is a flavor of Berkeley SPICE authored by Spectrum-Soft (<http://www.spectrum-soft.com/index.shtml>). You may download its simulation files from: <https://ufile.io/6psos3xr>

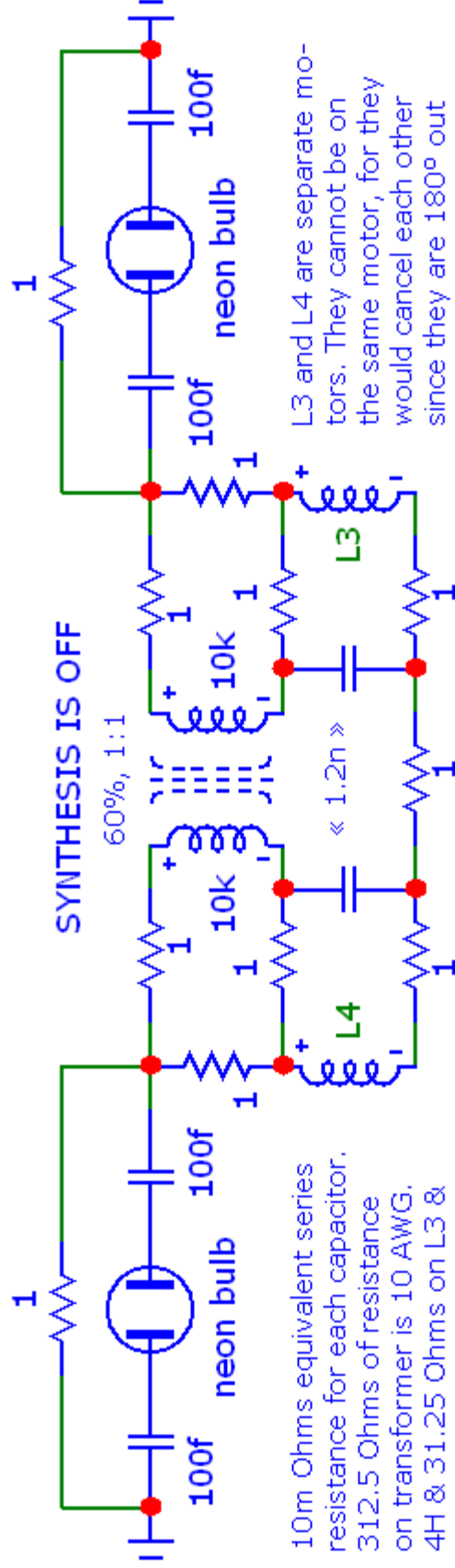

10m Ohms equivalent series resistance for each capacitor.
 312.5 Ohms of resistance on transformer is 10 AWG.
 4H & 31.25 Ohms on L3 & L4 are using ~34 AWG, each.

Zero Watts in 2½ min on L3 & L4.

L3 and L4 are separate motors. They cannot be on the same motor, for they would cancel each other out since they are 180° out of phase with each other.

gear approx. and 1 = reitot

INCREASE THESE 2 CAPACITORS FOR MORE POWER

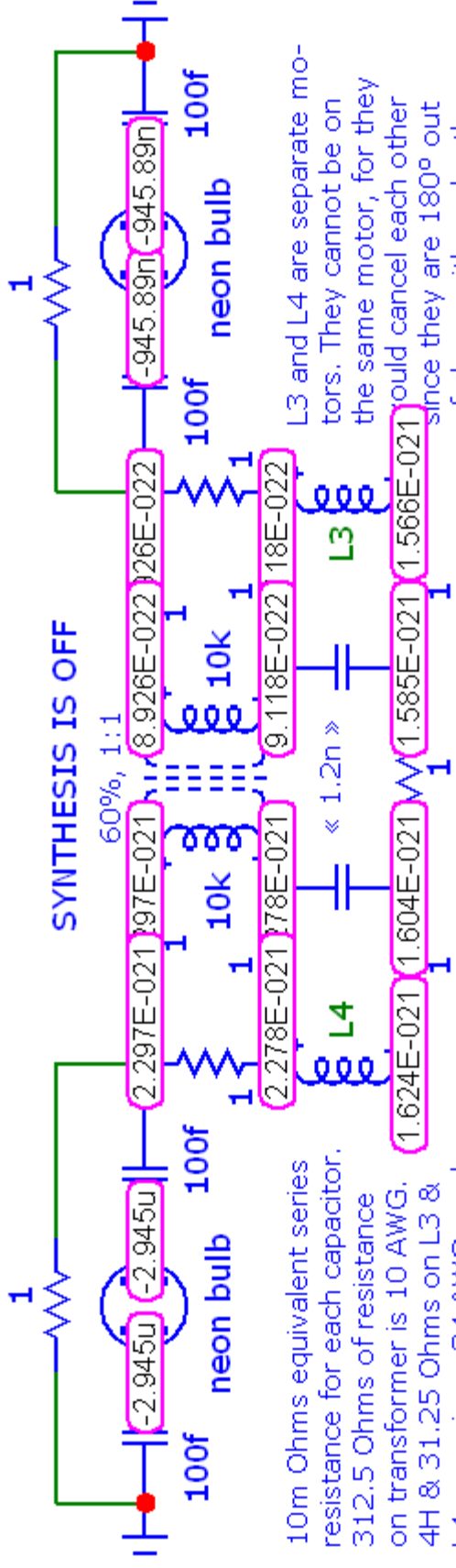

SYNTHESIS IS OFF

10m Ohms equivalent series resistance for each capacitor. 312.5 Ohms of resistance on transformer is 10 AWG. 4H & 31.25 Ohms on L3 & L4 are using ~34 AWG, each.

L3 and L4 are separate motors. They cannot be on the same motor, for they would cancel each other out since they are 180° out of phase with each other.

INCREASE THESE 2 CAPACITORS FOR MORE POWER

Zero Watts in 2 1/2 min on L3 & L4.

gear approx. and 1 = reitold

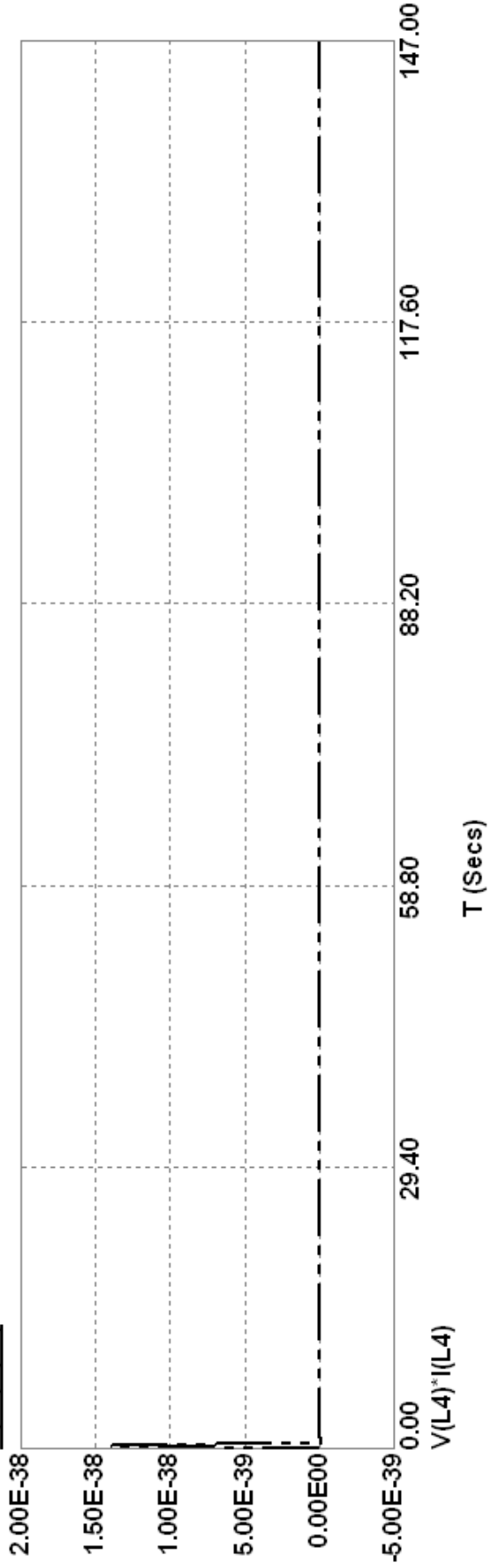
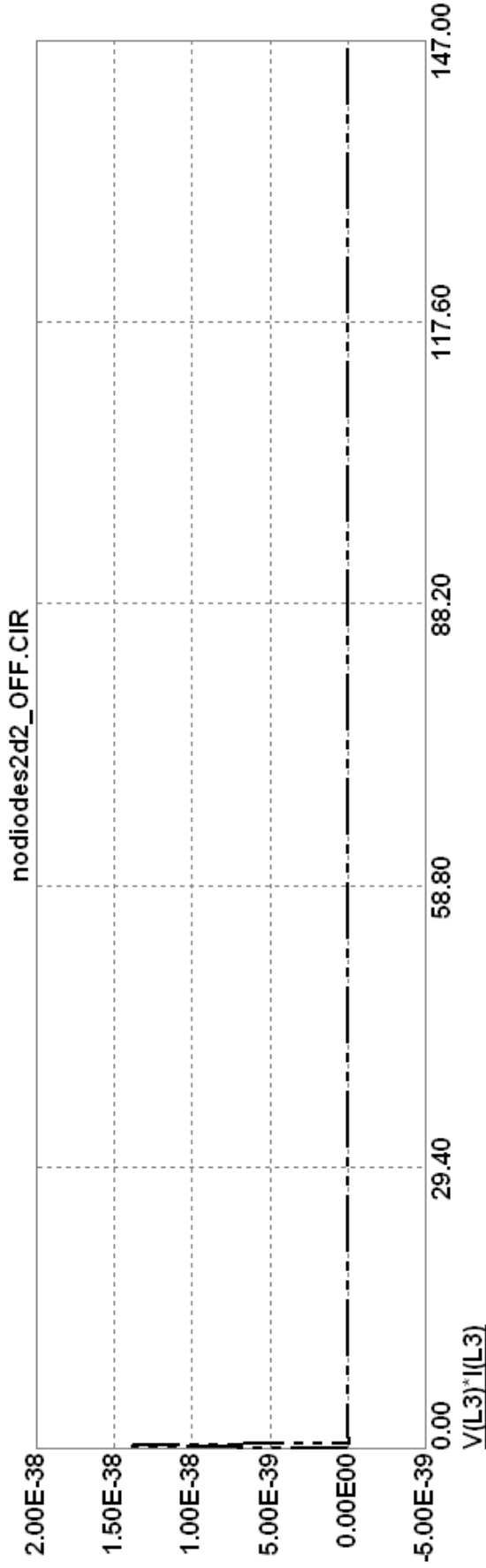

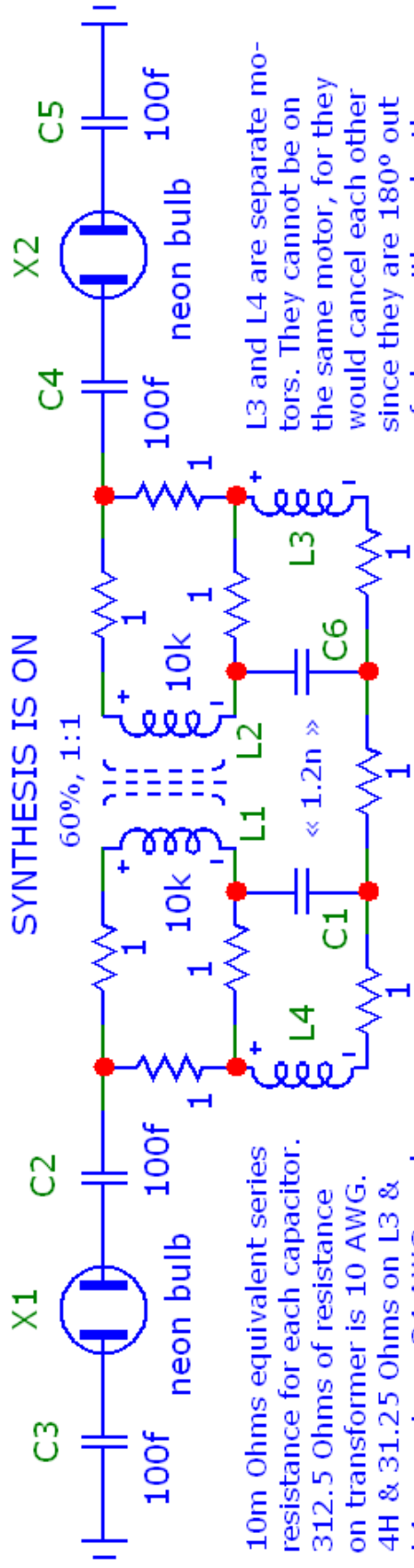

10m Ohms equivalent series resistance for each capacitor.
 312.5 Ohms of resistance on transformer is 10 AWG.
 4H & 31.25 Ohms on L3 & L4 are using ~34 AWG, each.

L3 and L4 are separate motors. They cannot be on the same motor, for they would cancel each other since they are 180° out of phase with each other.

INCREASE THESE 2 CAPACITORS FOR MORE POWER

81W+100W in 2½ minutes on L3+L4. gear approx. and 1 = reitol

SYNTHESIS IS ON

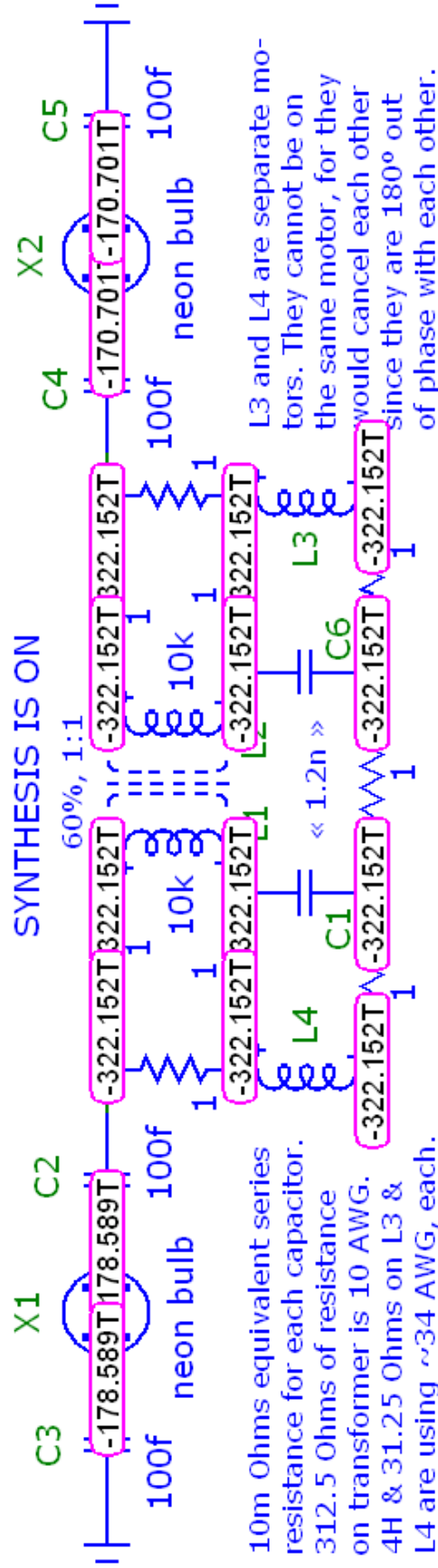

10m Ohms equivalent series resistance for each capacitor.
 312.5 Ohms of resistance on transformer is 10 AWG.
 4H & 31.25 Ohms on L3 & L4 are using ~34 AWG, each.

L3 and L4 are separate motors. They cannot be on the same motor, for they would cancel each other since they are 180° out of phase with each other.

INCREASE THESE 2 CAPACITORS FOR MORE POWER

81W+100W in 2½ minutes on L3+L4.

gear approx. and 1 = reitol

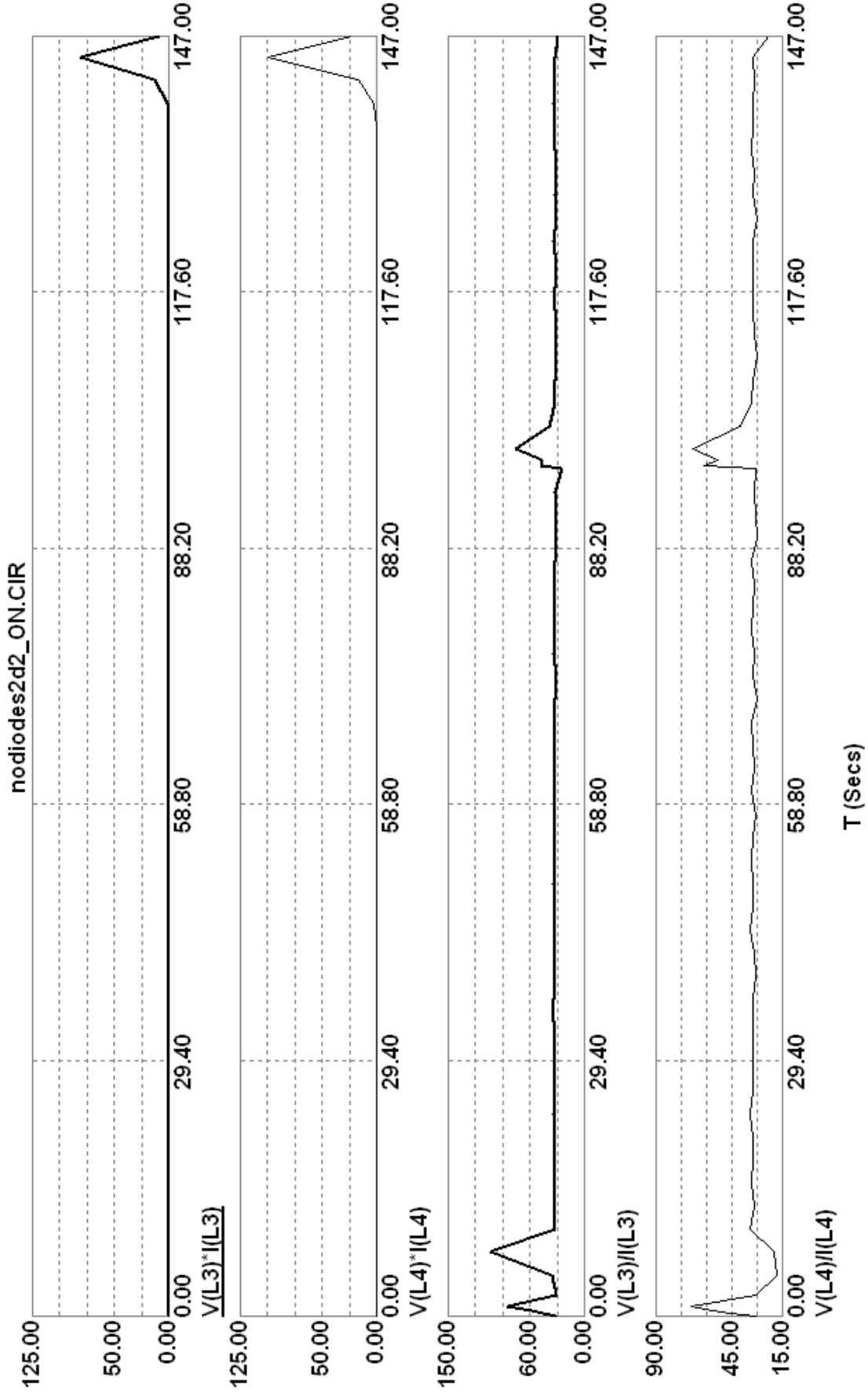

nodiodes2d2_ON.CIR

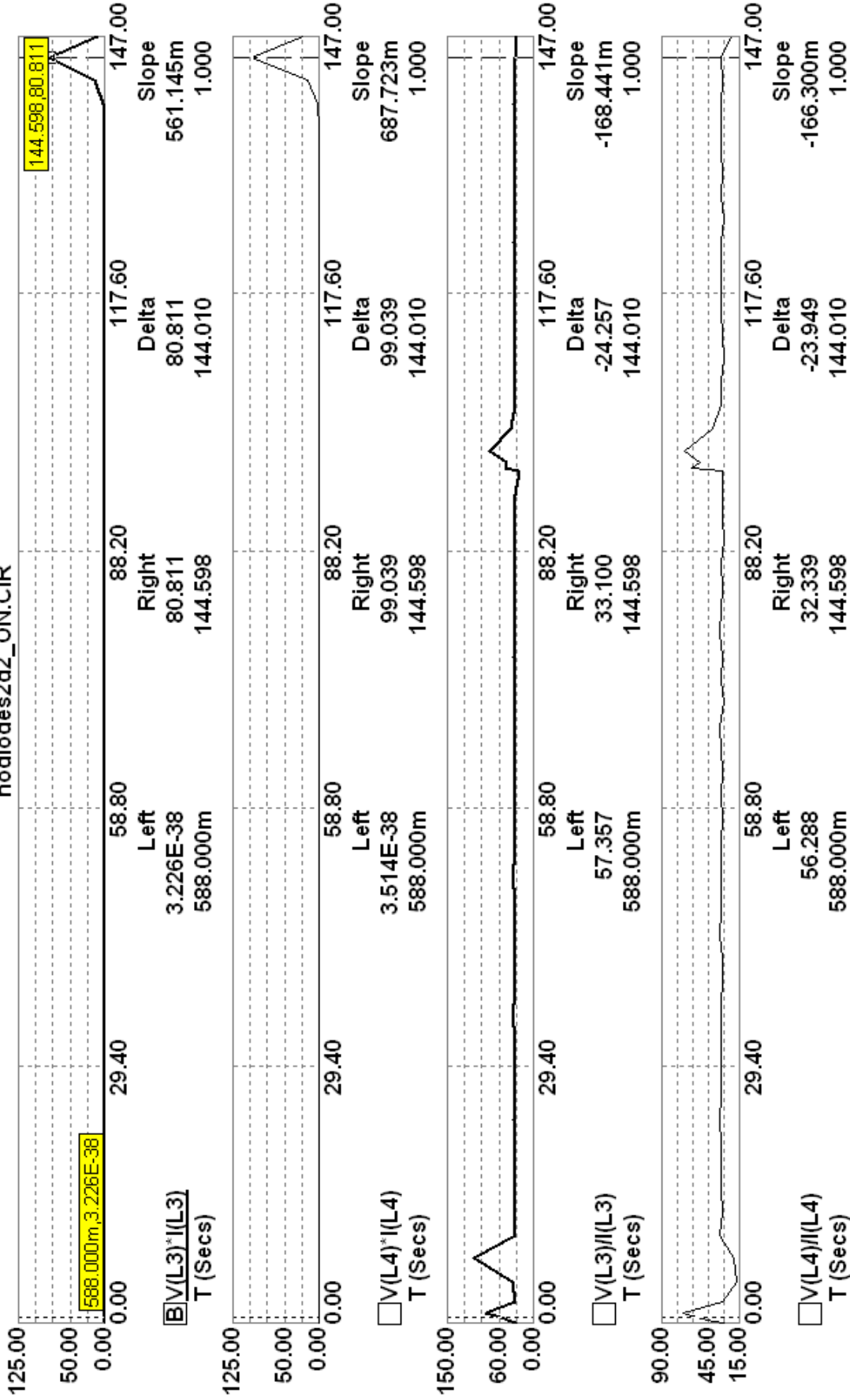

nodiodes2d2_ON.CIR

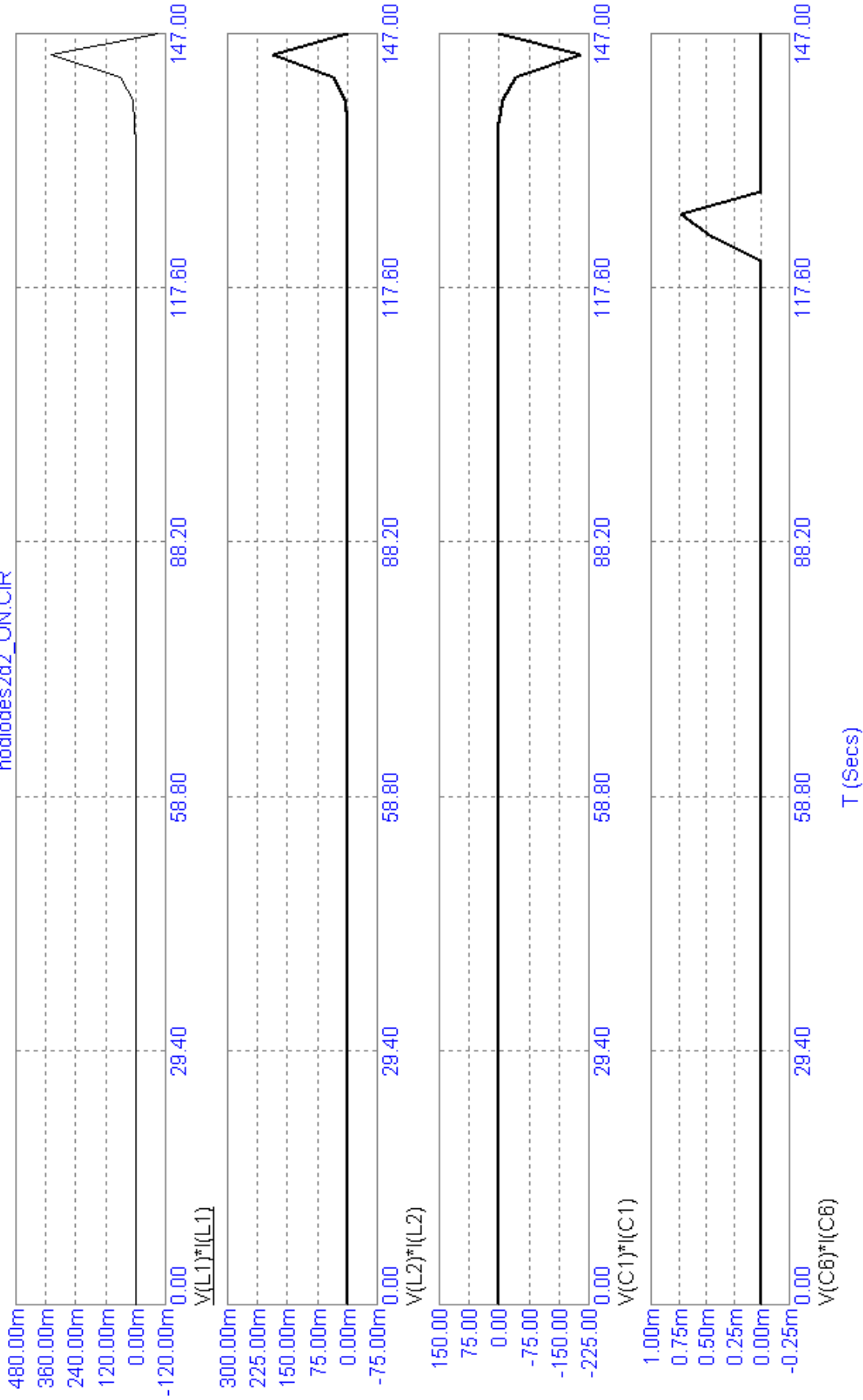

nodiodes2d2_ON.CIR

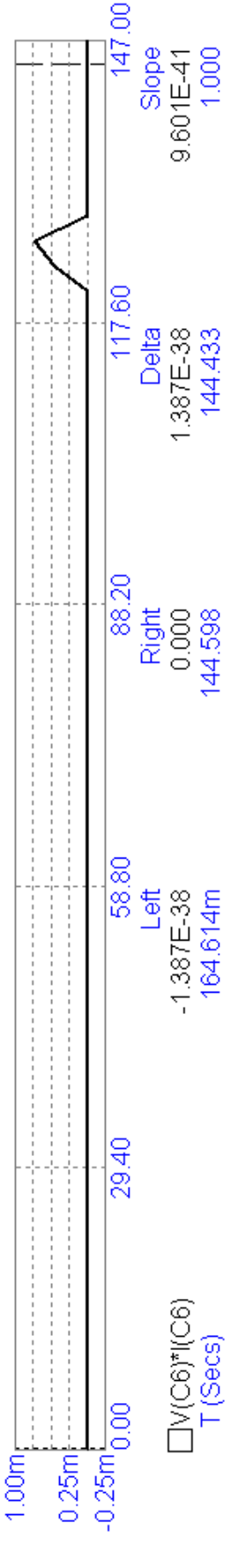
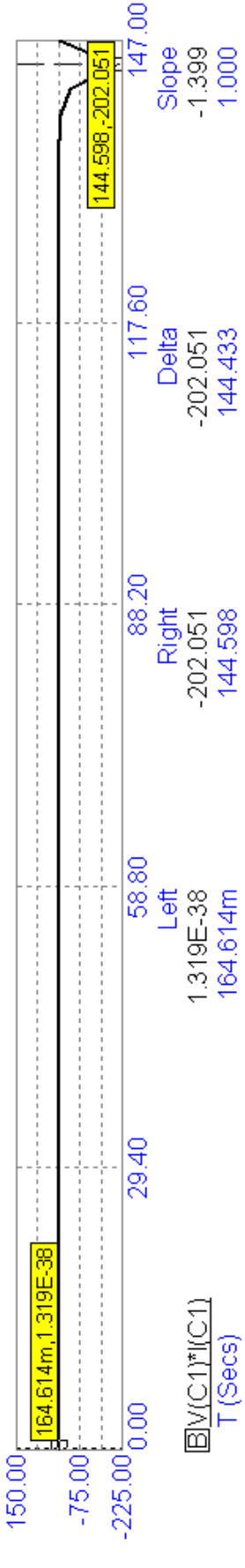
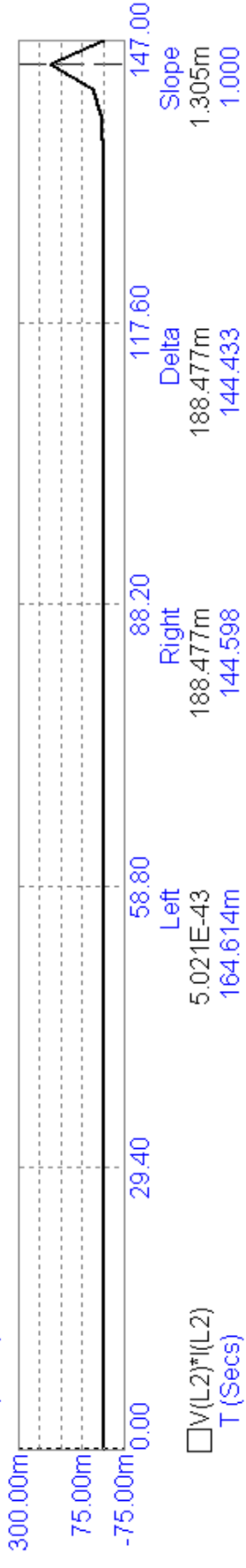
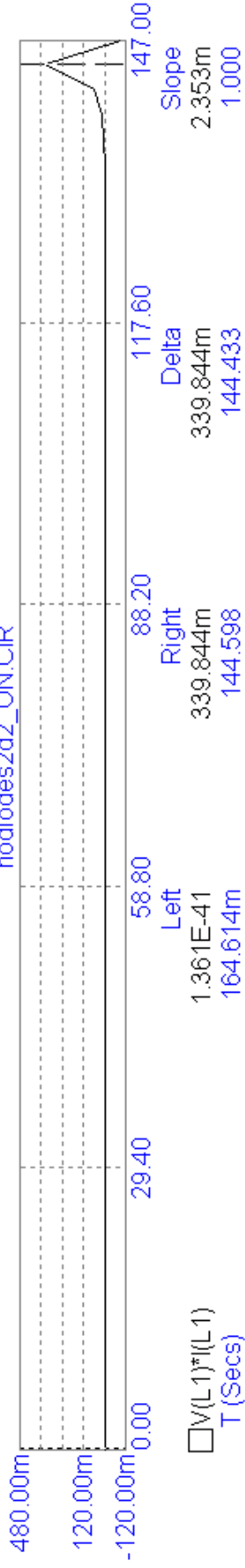

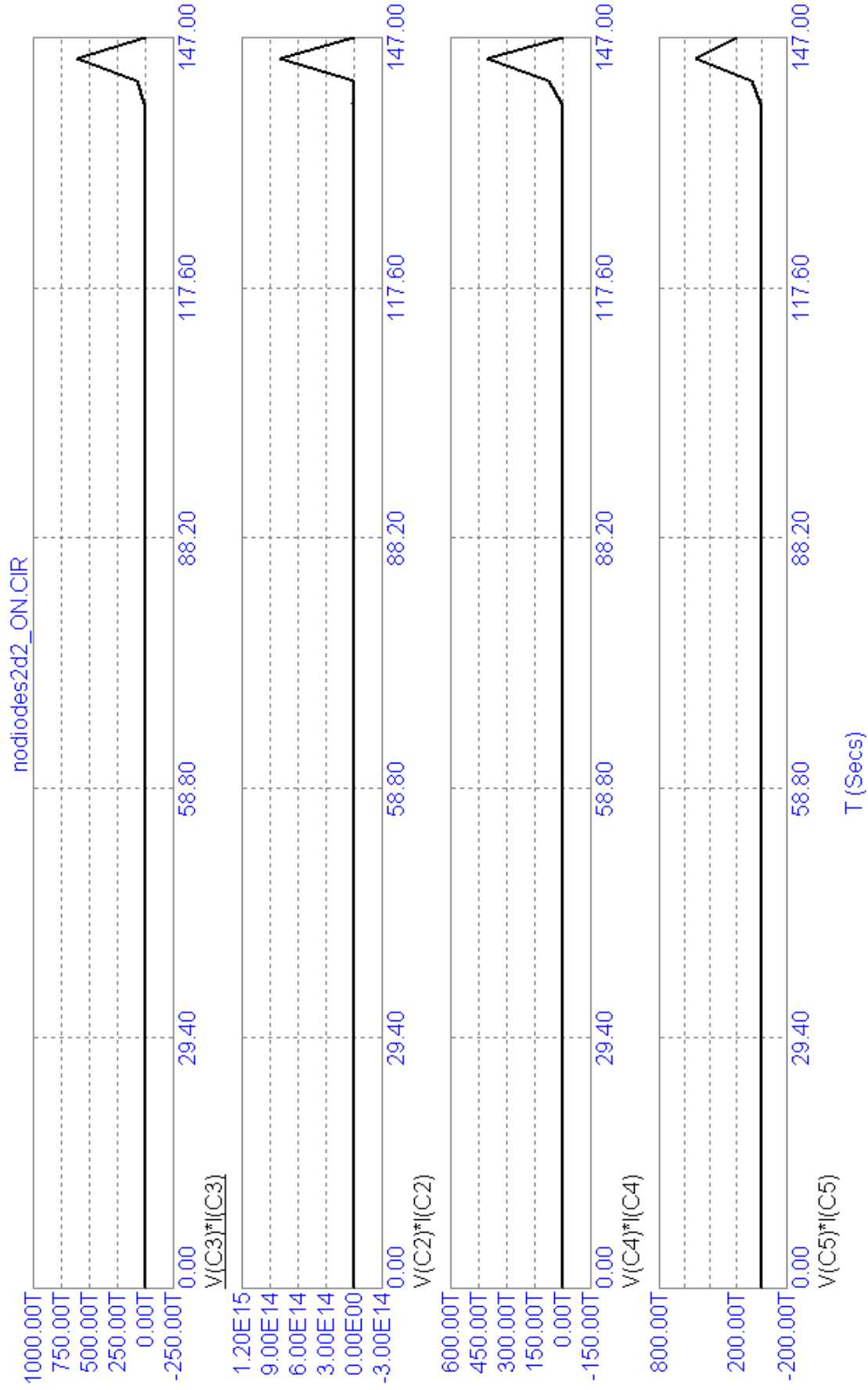

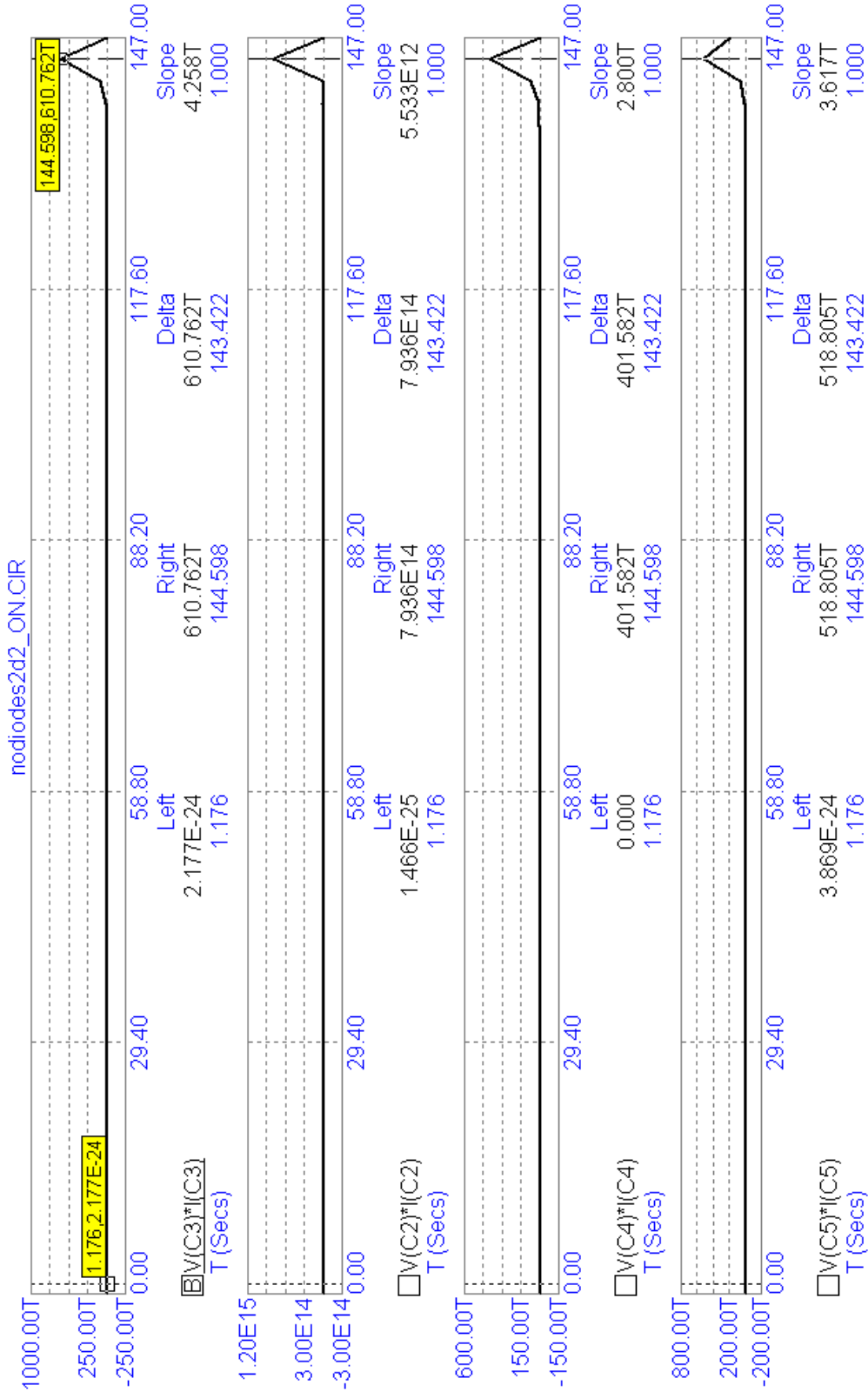

Nodal Voltages for X1 subcircuit, macro (Micro-Cap).

NEON BULB, SPARK GAP MACRO

.PARAMETERS(VTHRES=90, VARC=10, ISUS=500M,RNEG=-1,LPL=130N,RPL=2K,CPAR=1P,CARC=3P)

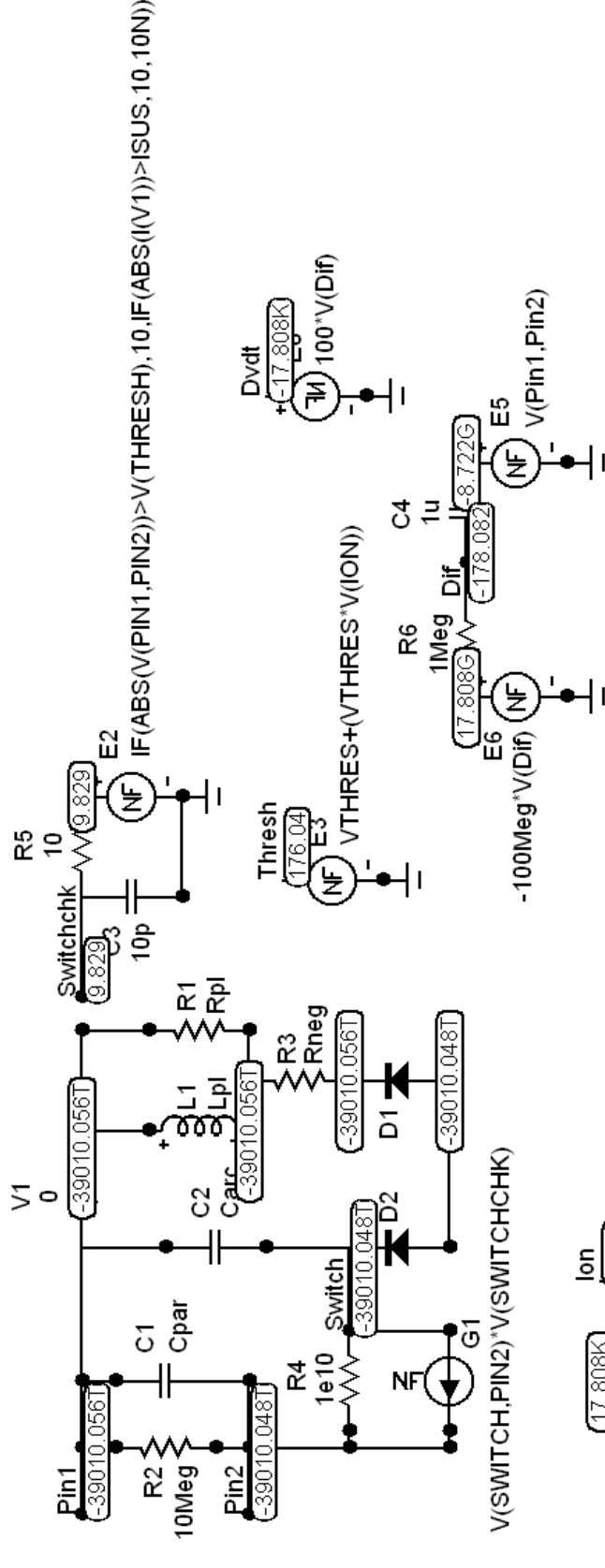

- .HELP VTHRES "Voltage at which the spark-gap strikes"
- .HELP VARC "Voltage across the spark-gap once struck"
- .HELP ISUS "Sustaining current under which the arc is stopped"
- .HELP RNEG "Negative resistance once struck"
- .HELP LPL "Lead/electrode inductance"
- .HELP RPL "Lead/electrode resistance"
- .HELP CPAR "Gap capacitance"
- .HELP CARC "Arc capacitance"

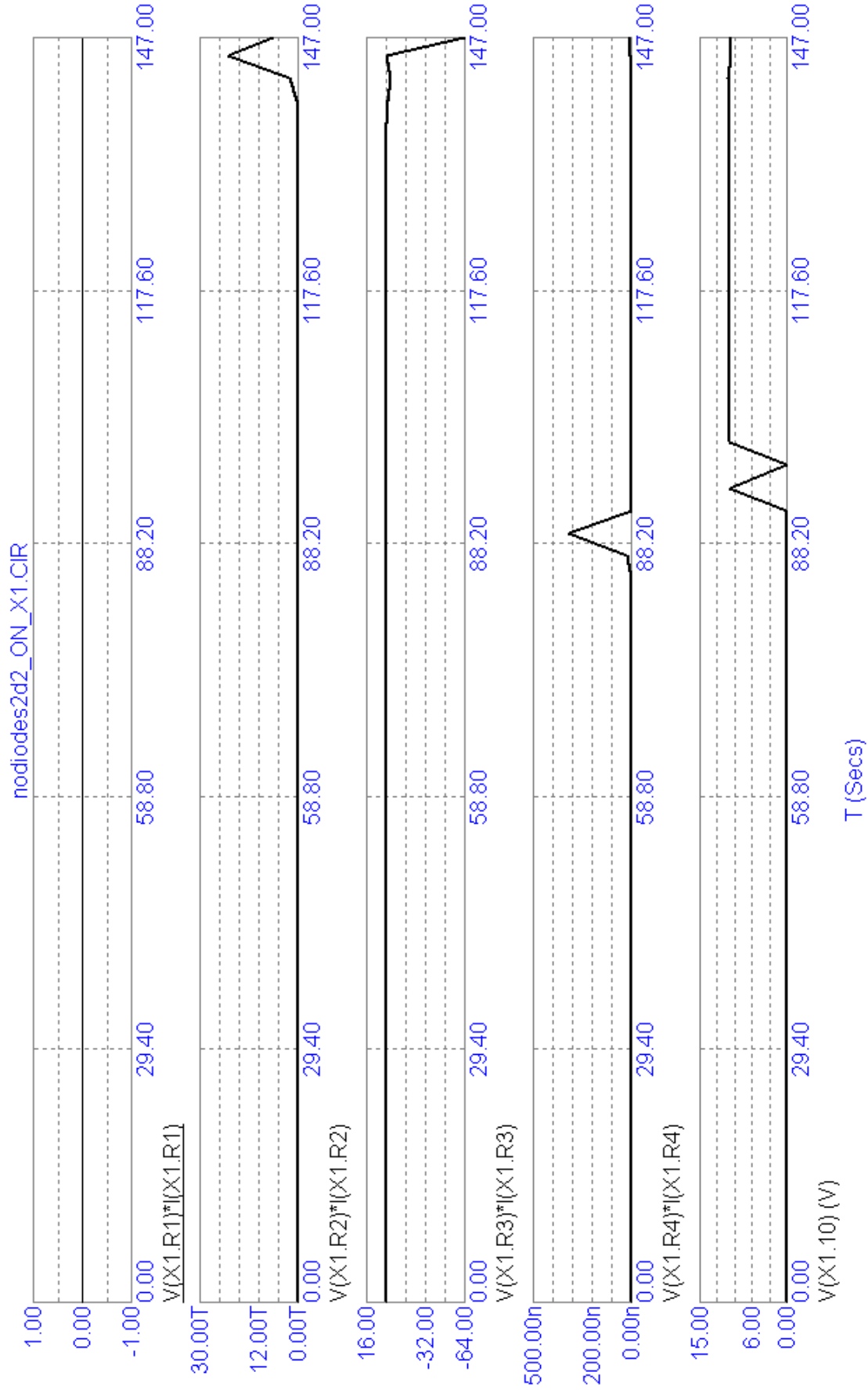

Node X1.10 tells us if this spark gap is ON if it equals ~10V. If ~10nV, then OFF.

nodiodes2d2_ON_X1.CIR

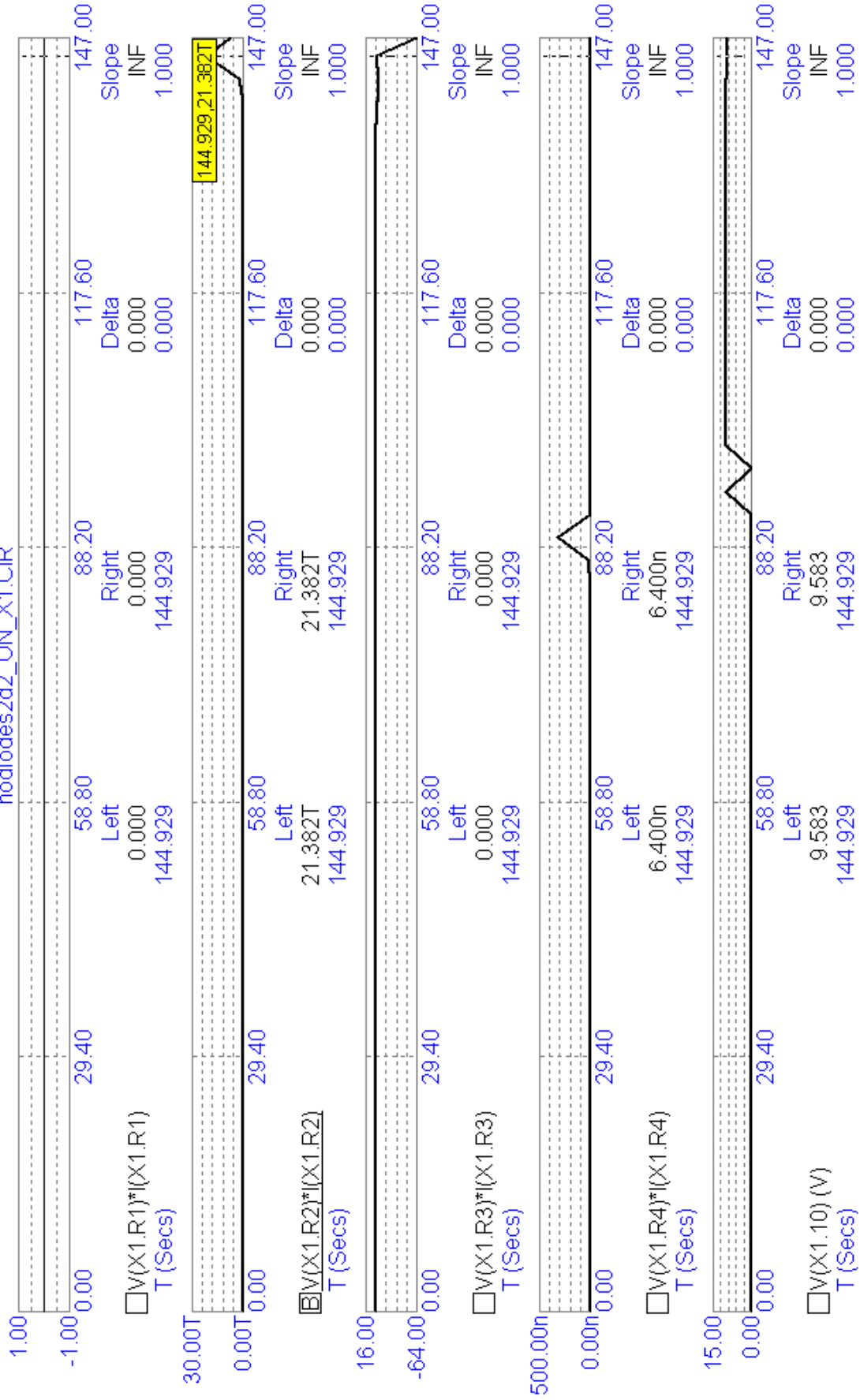

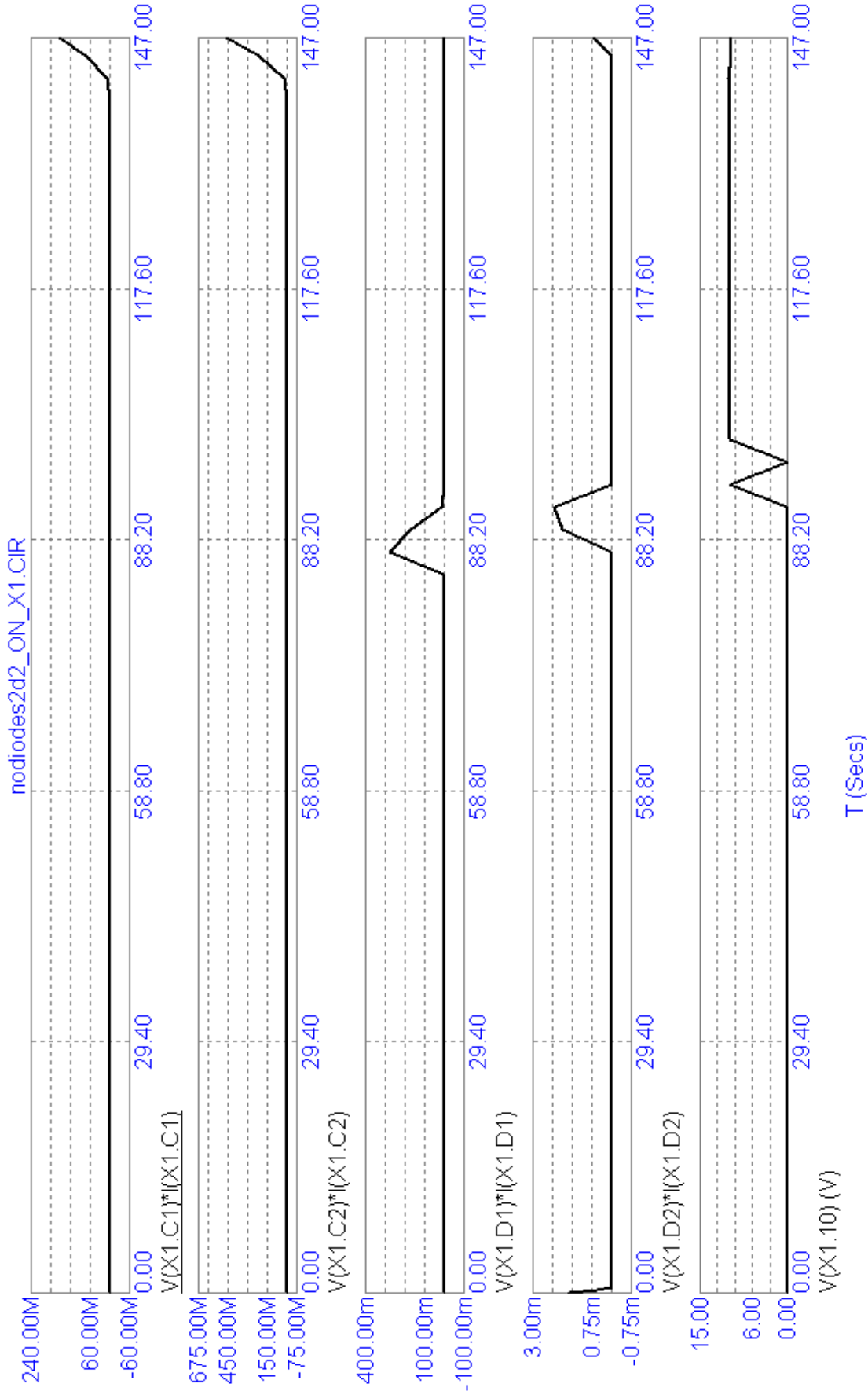

nodiodes2d2_ON_X1.CIR

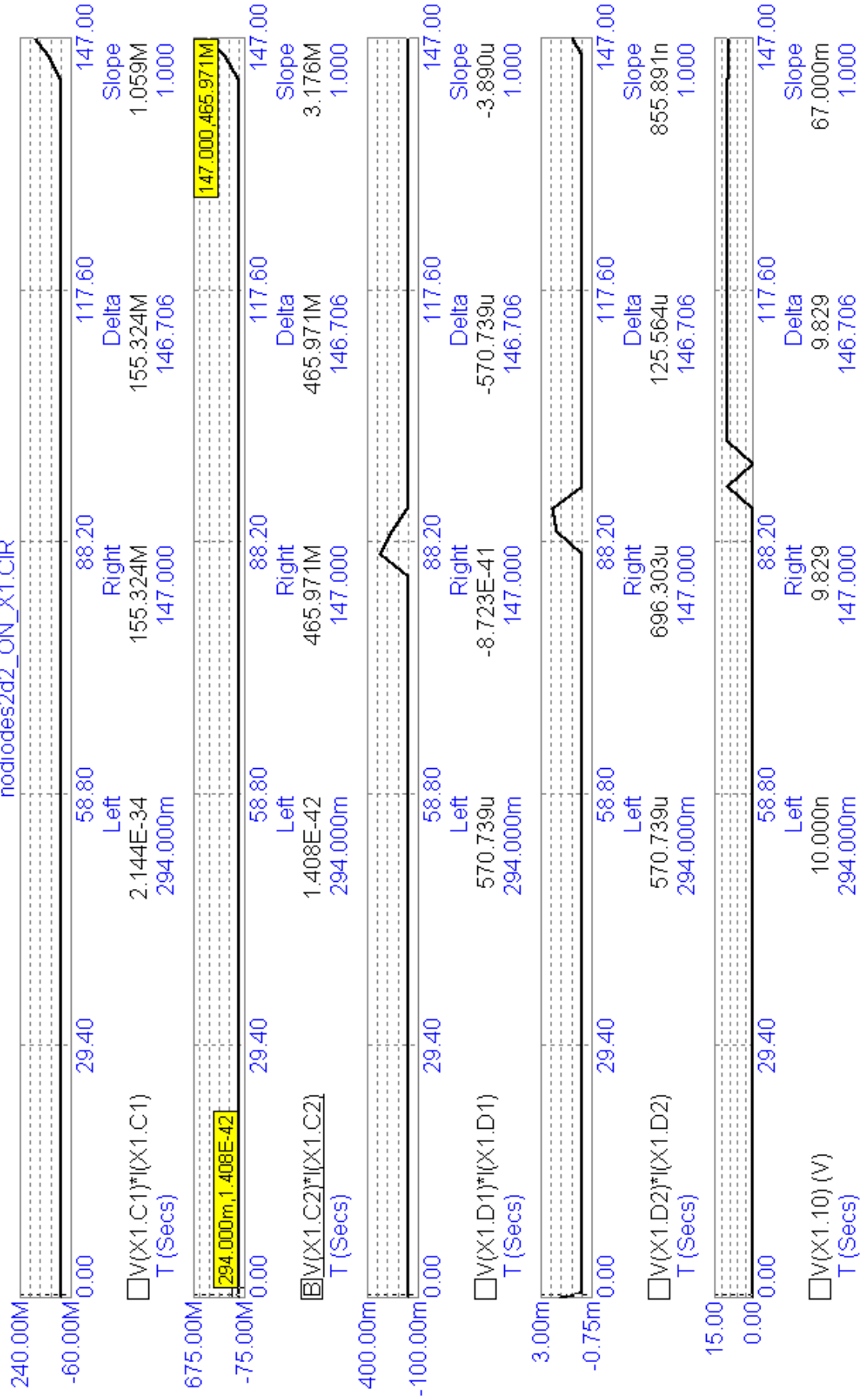

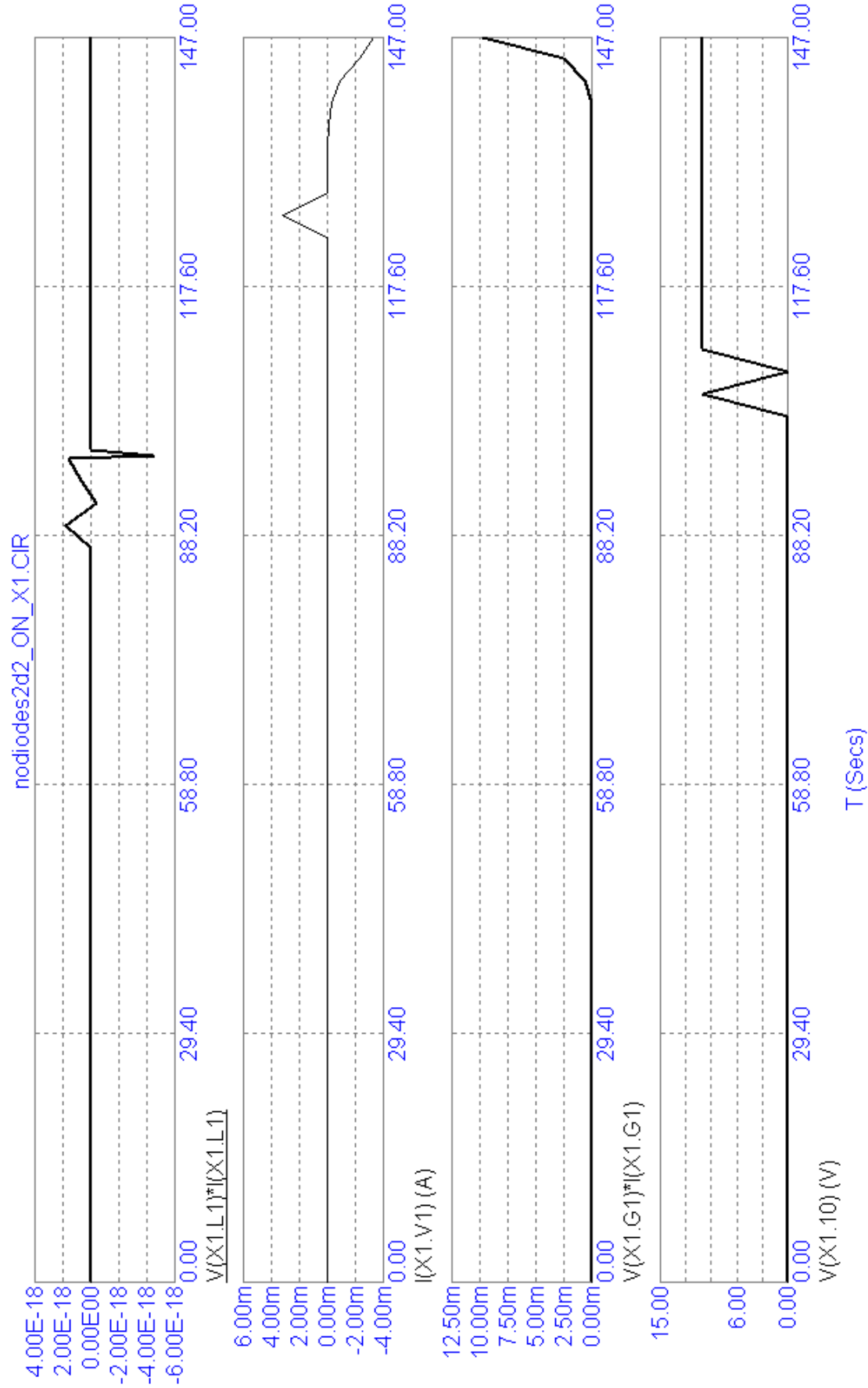

nodiodes2d2_ON_X1.CIR

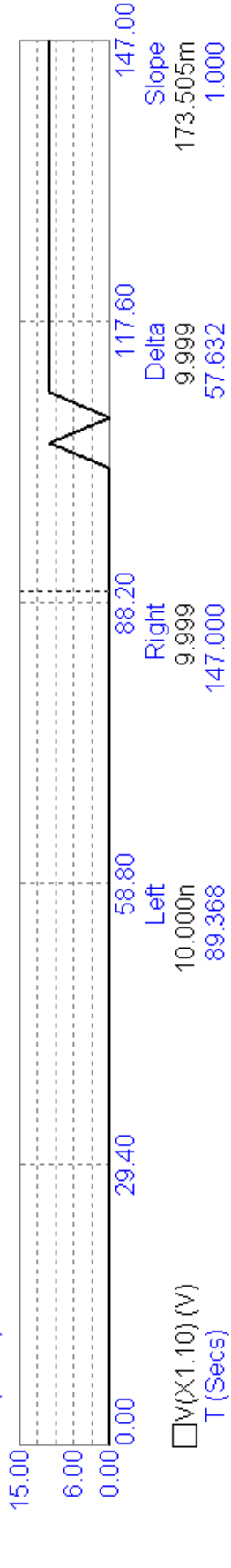
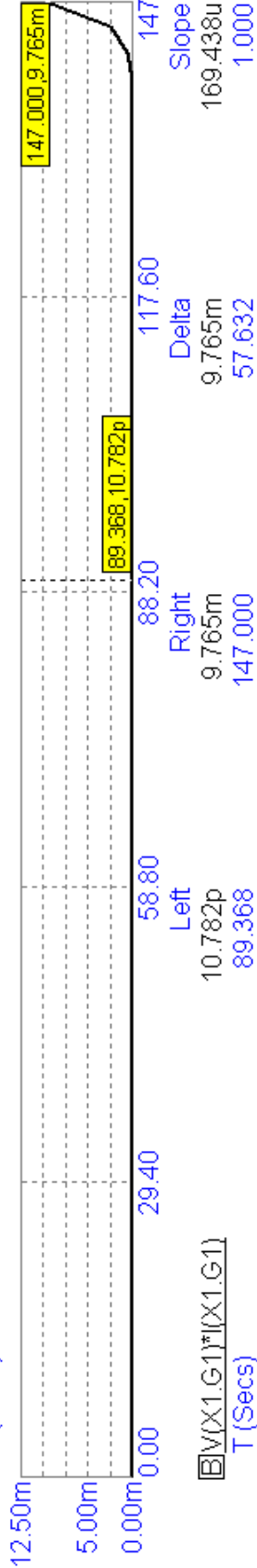
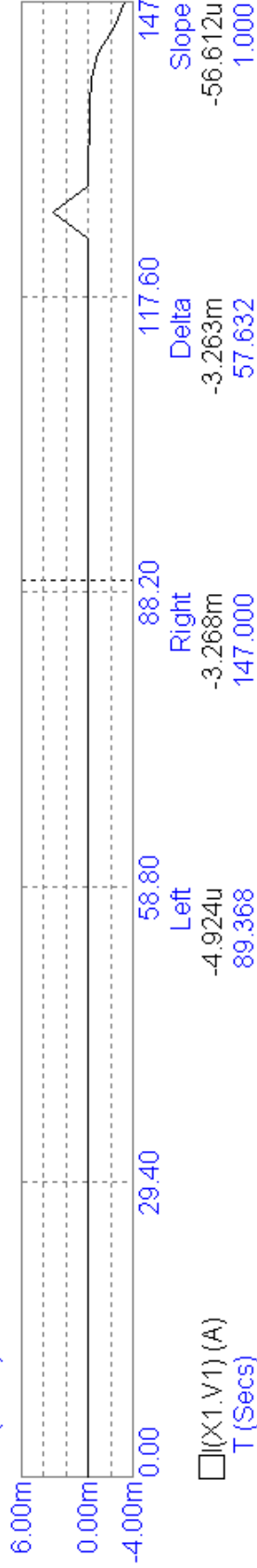
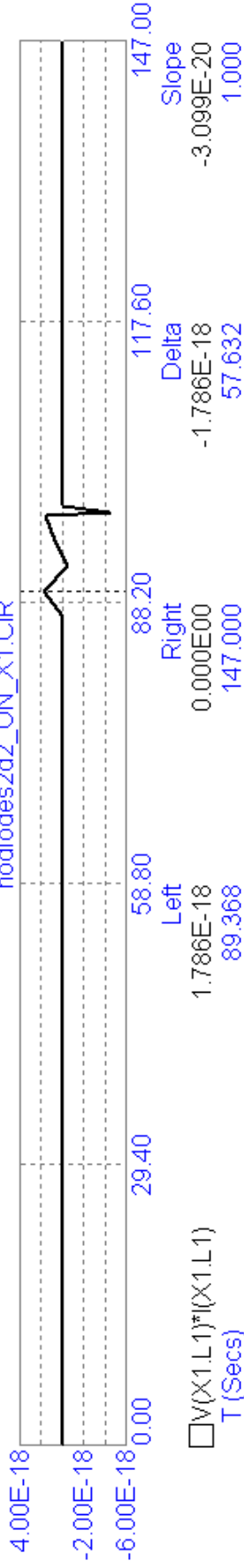

Nodal Voltages for X2 subcircuit, macro (Micro-Cap).

NEON BULB, SPARK GAP MACRO

.PARAMETERS(VTHRES=90, VARC=10, ISUS=500M,RNEG=-1,LPL=130N,RPL=2K,CPAR=1P,CARC=3P)

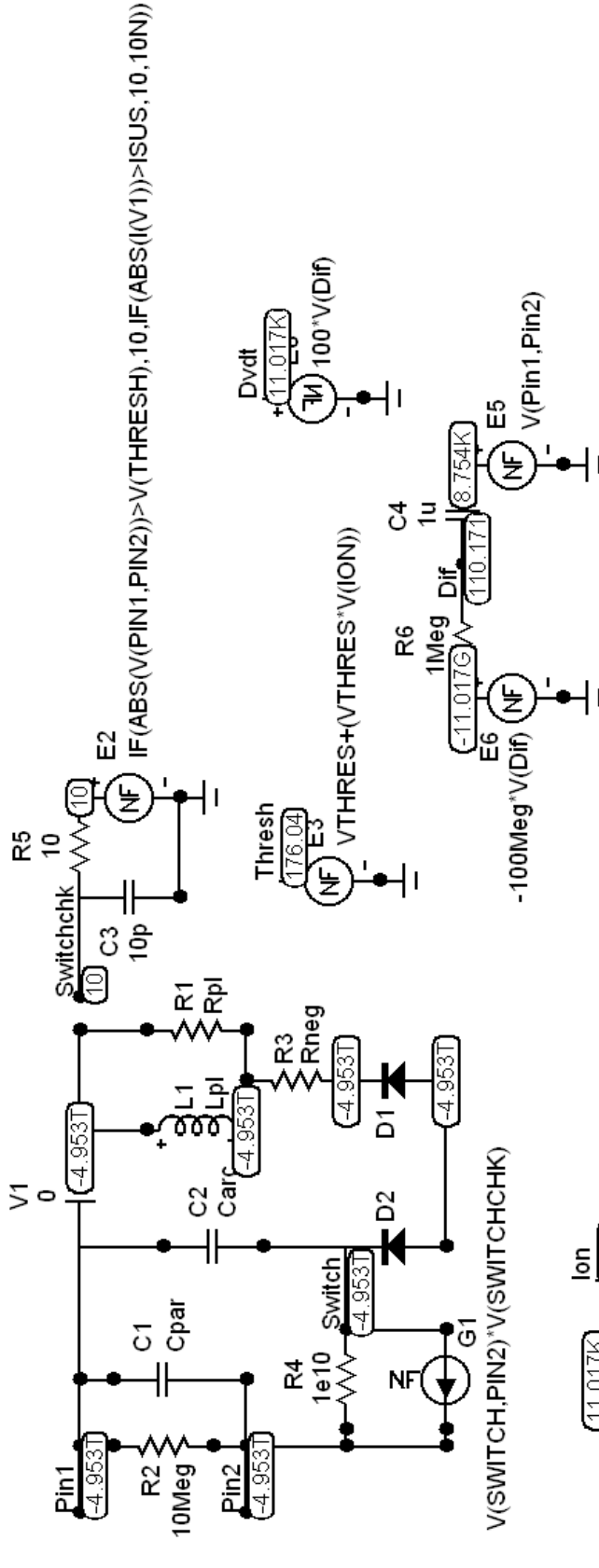

- .HELP VTHRES "Voltage at which the spark-gap strikes"
- .HELP VARC "Voltage across the spark-gap once struck"
- .HELP ISUS "Sustaining current under which the arc is stopped"
- .HELP RNEG "Negative resistance once struck"
- .HELP LPL "Lead/electrode inductance"
- .HELP RPL "Lead/electrode resistance"
- .HELP CPAR "Gap capacitance"
- .HELP CARC "Arc capacitance"

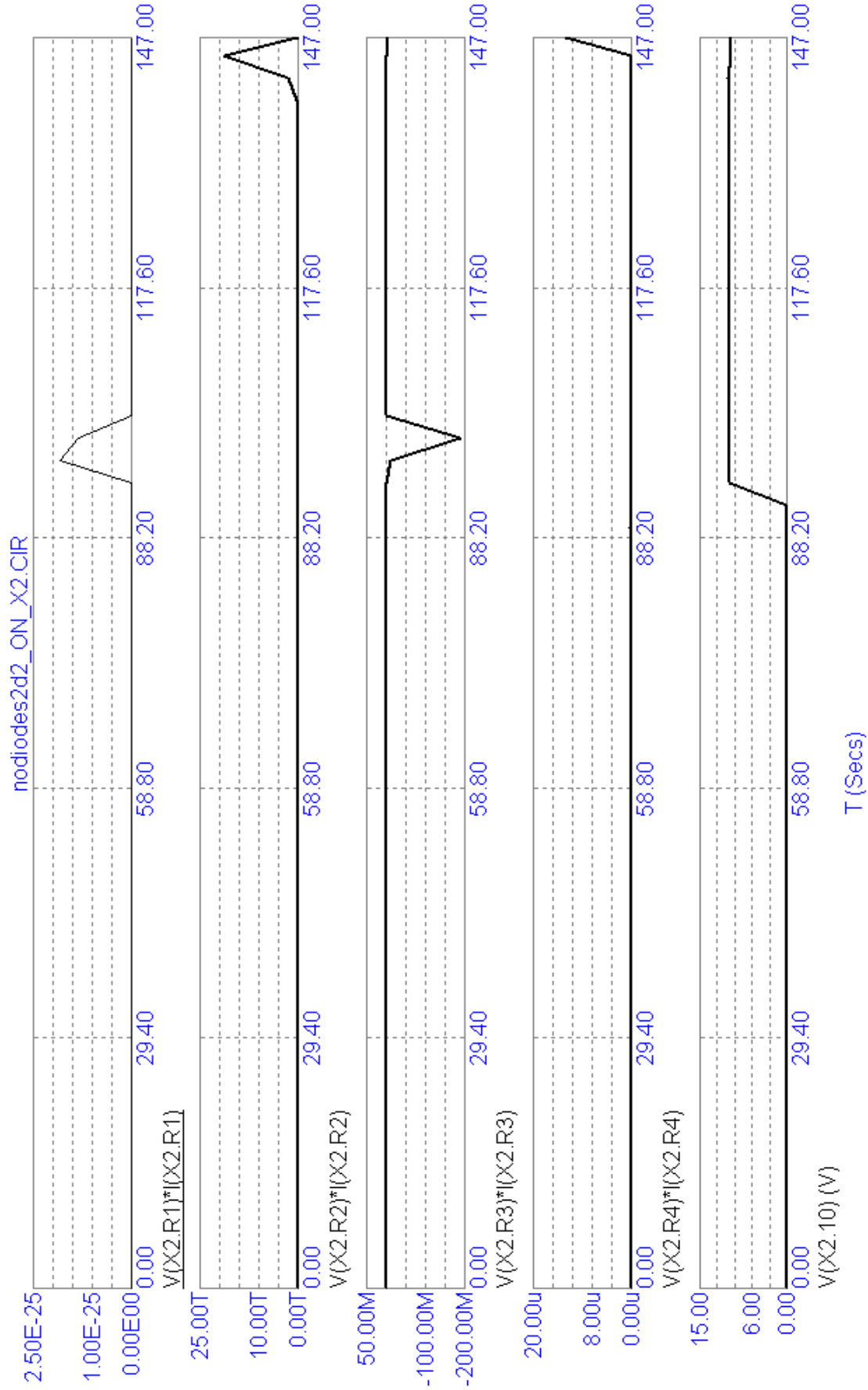

nodiodes2d2_ON_X2.CIR

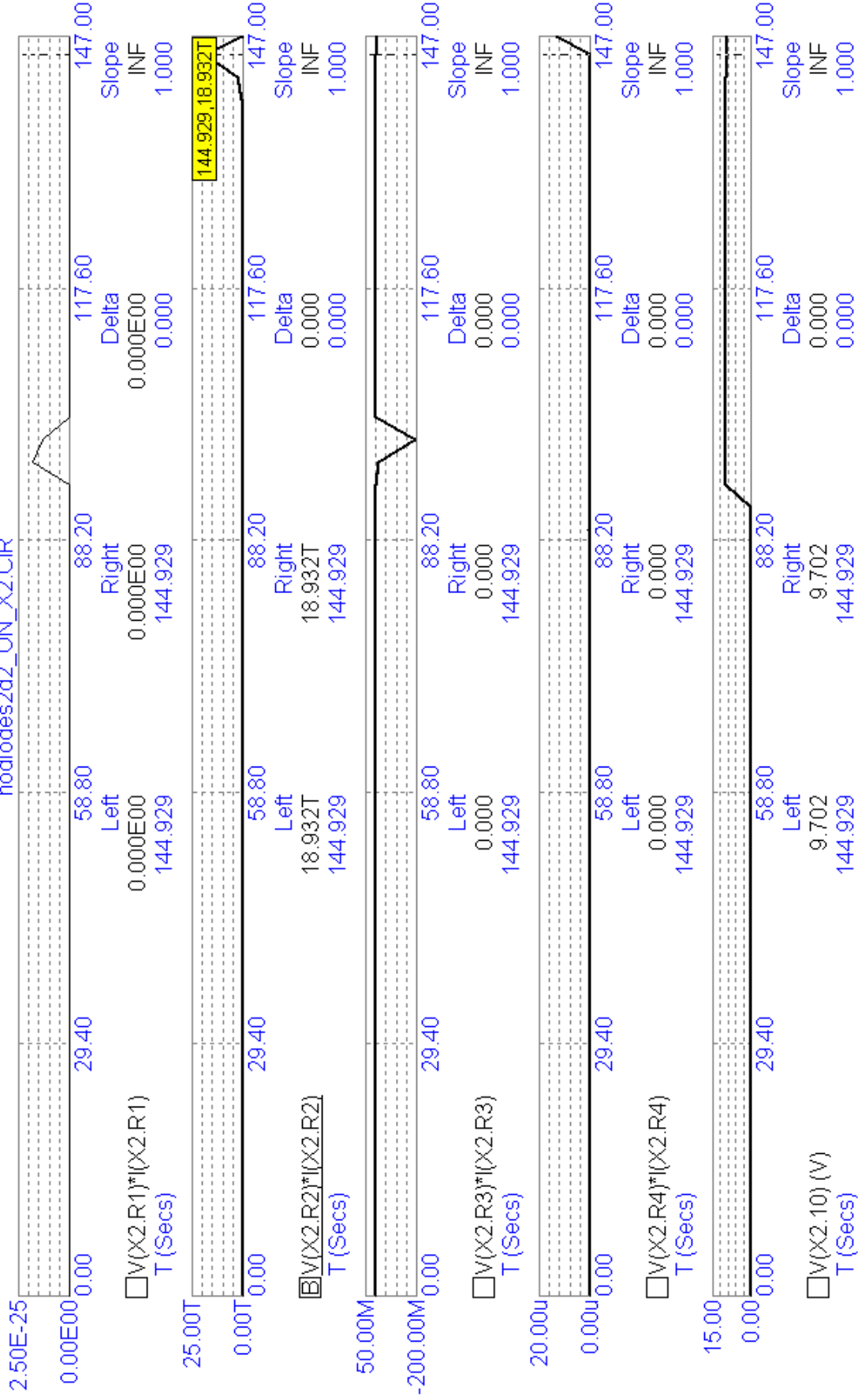

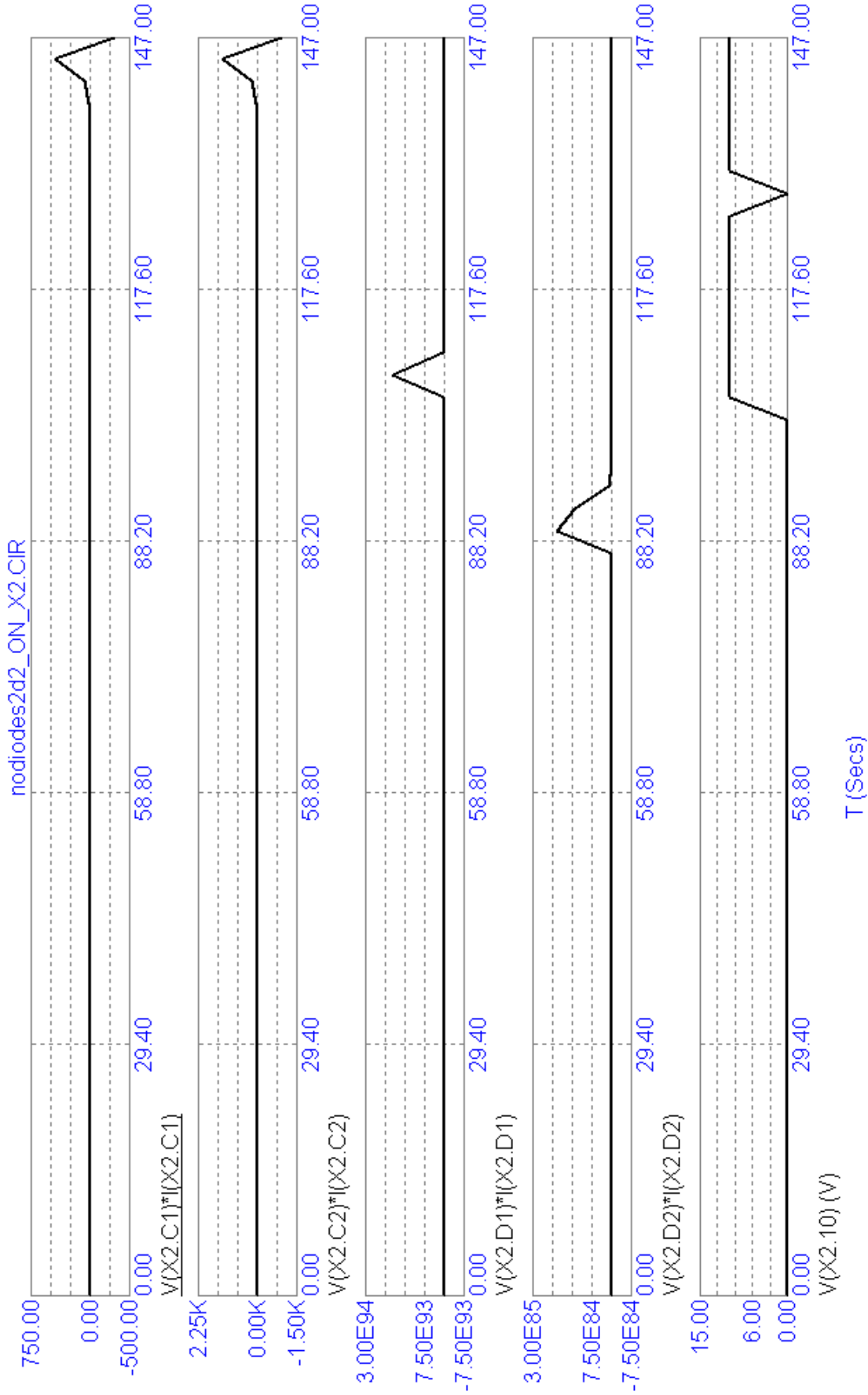

The following figures demonstrates how power is generated most of the time. Only occasionally does it react in the opposite (positive) direction to absorb, convert, and get rid of, this excess energy by spiking in the positive polarity once in a while.

So, causality has not been broken if we examine all of the components of a circuit over the entire duration of its run-time!

nodiodes2d2_ON_X2.CIR

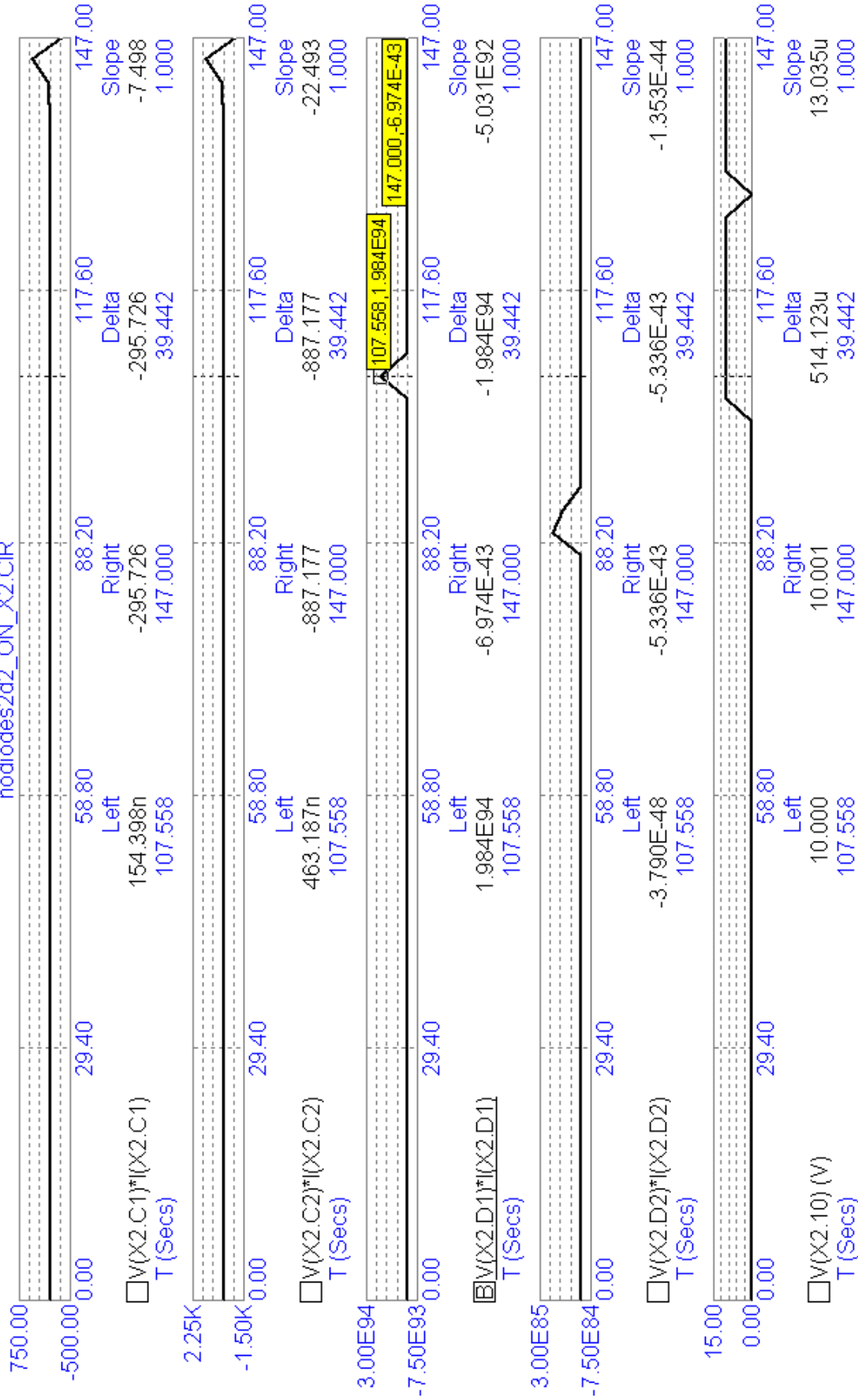

nodiodes2d2_ON_X2.CIR

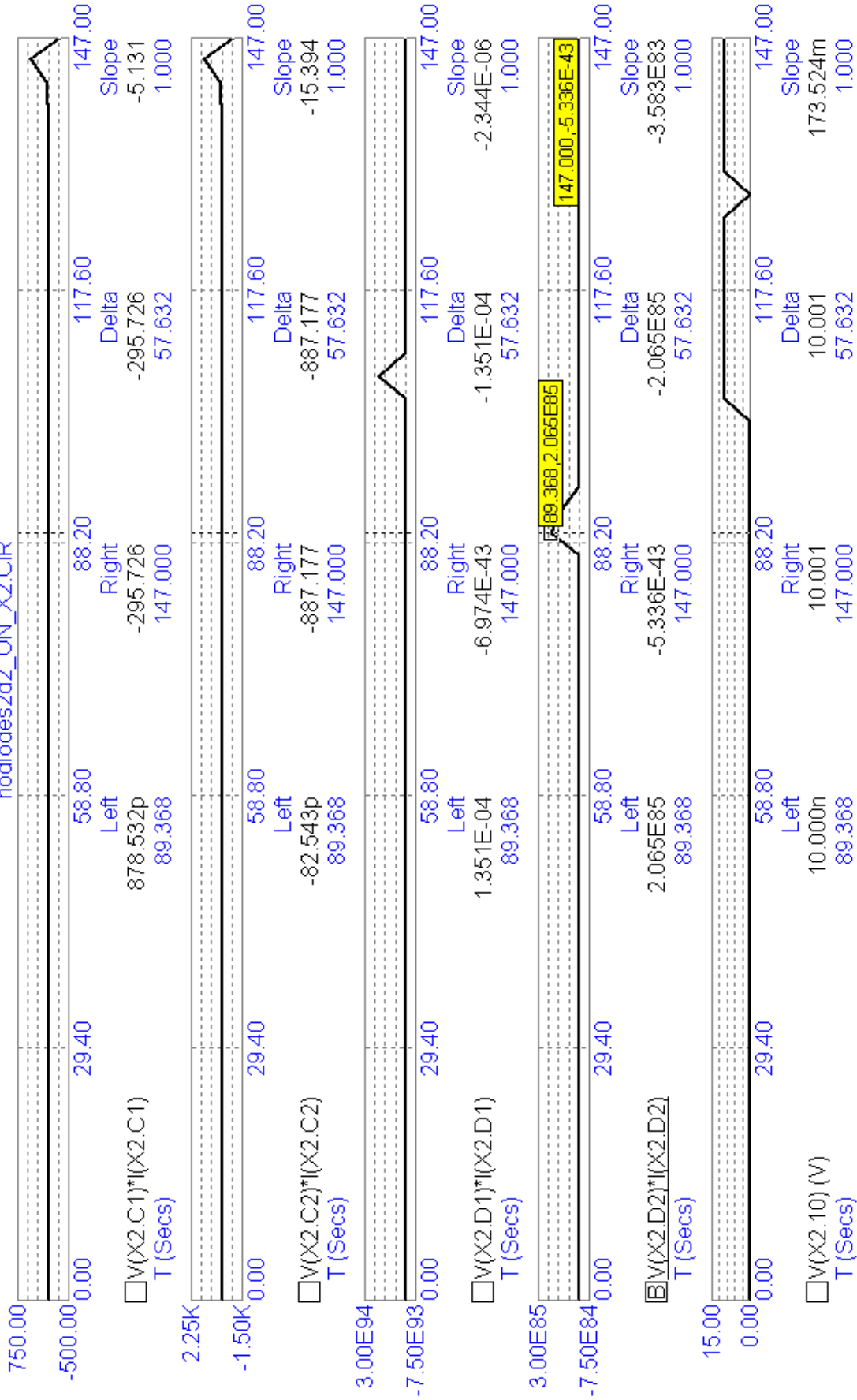

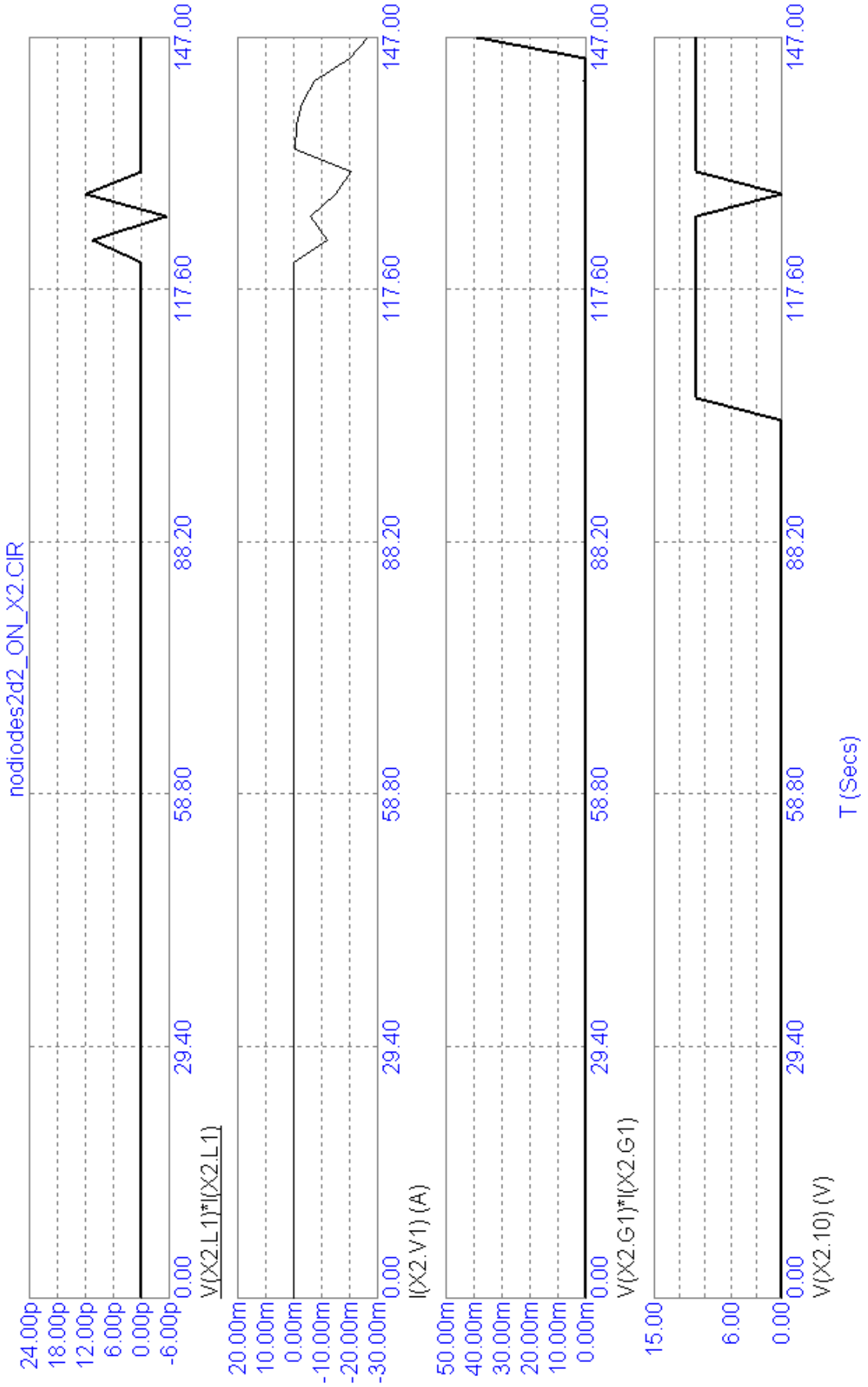

nodiodes2d2_ON_X2.CIR

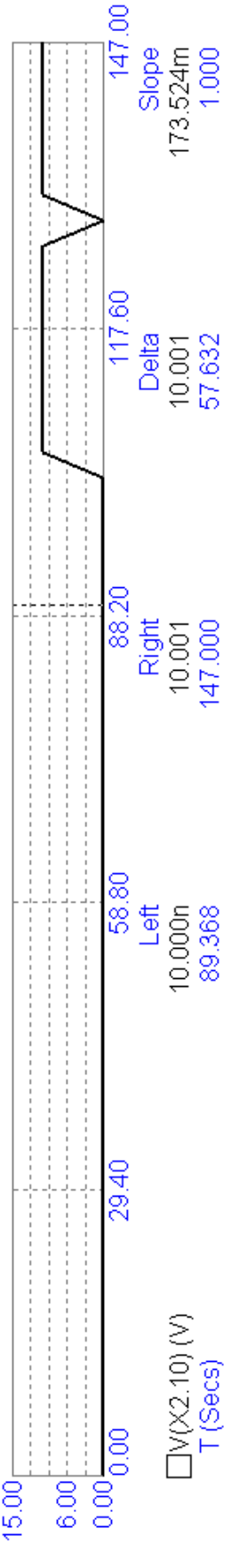
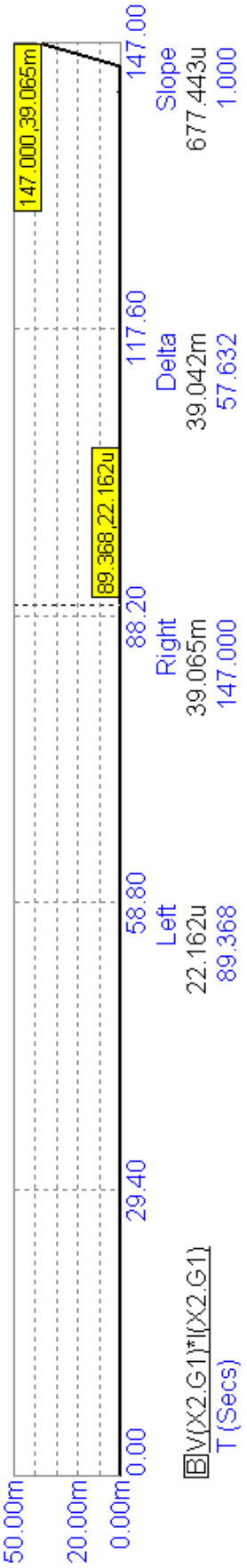
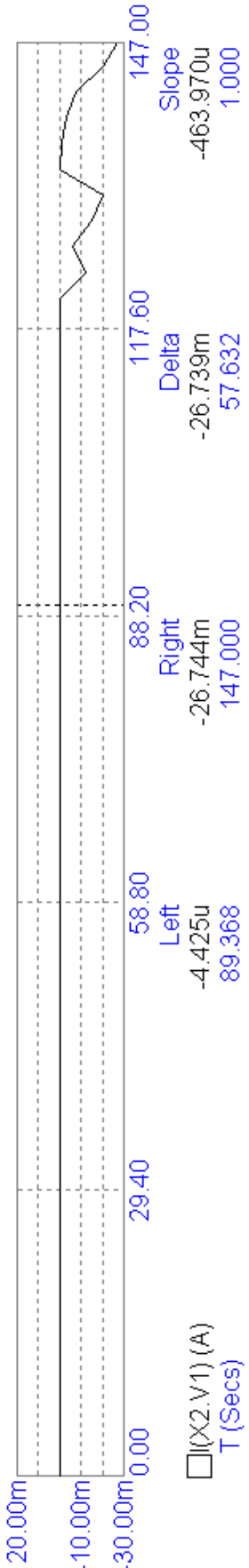
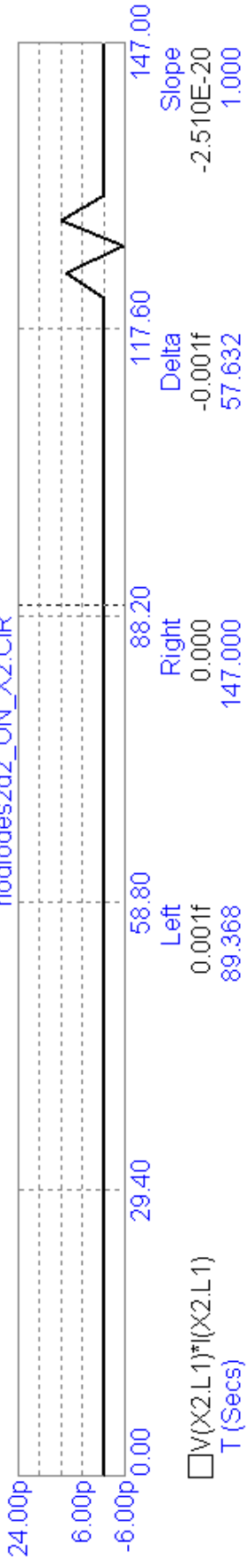

Why do we ignore “free energy?”

Because we are too preoccupied with energy while ignoring wave patterns.

The generation of energy is distinguished by a wave pattern called: a standing wave. These types of waves are rarely studied. They are the heart and soul of “free energy.”

A battery is an example of the conversion of the chemical energy which is stored inside of itself into electrical energy which exits its positive and negative terminals. Hence, it cannot generate energy; it merely converts energy from one format into another format.

The consumption of energy occurs whenever energy is being converted into another format, such as: electrical energy feeding a light bulb is converted into light and is distinguished by a wave pattern which moves. Hence, the battery and the light bulb inside of a flashlight circuit are not designed with the intention to generate power since that would give its owner a certain degree of freedom from having to purchase anymore power if he can generate his own power which he can't generate with a battery and a light bulb.

Yet, the arrangement of various electronic components (such as: capacitors and coils of wire, etc.) can sometimes generate power. And simple resistors, such as: heating elements, can convert the generation of this standing, electrical wave energy into useful heat energy and boil water to run a steam locomotive, or replace nuclear power at an electric power plant.

Energy always moves. Wave patterns move if they are merely consuming and converting power. Standing wave patterns do not move even though their energy is moving.

This is a very significant distinction we have been overlooking all this time arguing the pros and cons of free energy: is it a sham, or is it for real?

The theoretical evidence speaks for itself. Simulators are not the last word on this subject. Yet, they cannot be swept aside as rubbish, for that would deny their utilization by electrical engineers orchestrating the design for their new projects.

Hint...To interpret these slides requires looking at the polarity of sign for the value of each component. So, if a resistor possesses a negative sign out in front of its value for power, then this component is generating power and is a useless standing wave. On the other hand,

if a component possesses a positive polarity (indicated by the absence of any symbol for its sign), then that component is converting power into heat, or light, or the motion of a coil in an electric motor and must obey the laws of thermodynamics as they relate to conservation.

But the generation of power does not obey the law of the conservation of energy, because the generation of power is a standing wave. Its energy – inside of that wave pattern – conforms to the conservation of energy, but its standing wave pattern does not, because a pattern – in and of itself – is just a piece of information entertained by our mind. It does not exist in the concrete world of reality.

Yet we need these distinctions to help us to organize our thoughts on this subject.

So, from where does the extra energy come from whenever a standing wave clones itself? I don't know...

Some people have claimed that inventors who operate their “free energy” devices nearby any utility grid are stealing energy from that grid. That happened to C. Earl Ammann when he set foot within the jurisdiction of Washington, D.C., 100 years ago (in 1921) to deliver to the United States Patent Office his electric car powered by his invention devoid of the use of any batteries. He was promptly arrested before he could ever deliver his invention to the Patent Office on the grounds of his, “stealing energy from the grid.”

I think it was a bogus charge.

I think he was disrupting the utility grid located at the perimeter of his influence while supplying energy to the people located well within the diameter of his power supply's range of influence which was several miles mostly covering downtown Denver, Colorado, where he and his brother conducted their demonstration.

I asked the following question to the good people over at Stack Exchange (<https://is.gd/ugjif>) ...[archived – <https://is.gd/ejikir>]
Does the Conservation of Energy pertain to the electrical energy within all wave patterns (regardless of their form or function), but does not pertain to the wave pattern, itself? In other words...

Does the Conservation of Energy restrict its domain to electrical wave patterns which merely convert one form of energy into another

form of energy, such as: batteries and incandescent light bulbs?

And does the Conservation of Energy not apply to electrical wave patterns, such as: standing electrical waves whose phase of current is inverted relative to their phase of voltage by 180 degrees of separation?

For, I see a distinct pattern emerging in which electronic components, such as: batteries and resistive loads (such as: light bulbs) exhibit wave form patterns which are indicative of the consumption of energy due to the property that their wave forms move. This is indicative of energy moving (which is undergoing conversion) from one domain into another domain. Yet, is this contrary to the behavior of standing wave patterns, whose patterns do not move, despite the energy which is inside of standing wave patterns does allow for the movement of energy inside of their rigid wave pattern?

Hence, light bulbs exhibit their beneficial outcome of making electrical energy useful by converting it into light and radiate this outwardly, or else batteries make the chemical energy stored within themselves useful by converting this energy into electrical energy to power a light bulb. So, it makes sense that this conversion process must conform to a sensibility of conservation since no new energy is being produced.

But, does this explain the behavior of all electrical wave patterns? What about standing waves? Their energy is conserved, but is their wave pattern capable of cloning itself?

And what is the consequence of this ability to clone itself?

Must these wave-types steal energy from their environment in order to fulfill their function of endlessly making carbon copies of their wave forms? Is this what, so-called, “free energy” amounts to...is to find a source of energy exterior to a circuit from which to steal in order to succeed at cloning its standing wave form?

Or, is there another source from which to “steal” so-called “free energy,” namely: the future of the energy which resides inside of a standing wave? In other words, is electrical energy capable of reversing its own time-domain whenever this type of standing electrical wave encases electrical energy?

This question pertains merely to those types of standing waves which possess a phase separation of one-half cycle of oscillations

between the current phase and the voltage phase components of an electrical wave of energy (to distinguish this usage of the term, “standing wave,” from other types of standing waves).

Yes, a wave pattern existing as a calculated quantity. That's what I intend to imply. And two different types of waves categorizing (organizing) wave behavior into two broad groups of the consumption and conversion and, thus, the diminishment of their electrically, energetic waveform (which moves its position in space) versus their amplification of power due to their electrical, standing wave pattern which does not move around in space, yet may be moving around in time resulting in their amplification instead of dissipation? And from where does this extra energy come from: their future position in space (should their two phases of current and voltage be brought back together)?

“Amplification instead of dissipation” reflects the reversal of current as a property which is oriented by pointing itself away from areas of higher voltage and points its orientation towards areas of lower voltage accentuating their voltage differences rather than equalizing them (negentropy).

Please replace all instances of the word, “pseudoscience”, with the phrase of “the virtual reality of electronic simulators derived from the Berkeley SPICE model,” specifically: Micro-Cap by Spectrum-Soft.

So, I must assume that the use of the term of, “pseudoscience,” implies that there is no scientific answer to this question? Okay. I understand and appreciate your comments.

The following three images are relevant to my text. But Amazon altered their rules for publishing paperback books increasing the minimum number of pages from 24 to 72. So, I went online and gathered up 40 free clipart images to pad out my submission.

The first of these three images is a scanned newspaper article dated 28 August 1921. The second image is the original photograph used in this article. And the third image is a portrait of Michael Faraday. Enjoy!

SUBSTANTIAL CUT IN PIERCE-ARROW PRICE ANNOUNCED

A substantial reduction in the prices of its touring car models effective after September 1, and a reduction on the prices of its truck models, effective immediately, has been announced by George W. Mixer, president of the Pierce-Arrow Motor Car company.

The new price of the standard seven-passenger touring car is \$6,500 at the factory, the enclosed car prices being graded proportionately.

The new prices of its truck models are: \$4,950 for the five-ton size; \$4,350 for the 3½-ton and \$3,200 for the 2-ton.



This Tire

ELECTRICITY "TAKEN FROM AIR" DRIVES AUTOMOBILE



C. E. AMMANN AND HIS "ATMOSPHERIC GENERATOR" ATTACHED TO AN ELECTRIC AUTOMOBILE

DENVER, Colo., Aug. 26.—Demonstrations are being made on the streets of Denver of a new electric generator that is claimed by the inventors to take electricity from the air.

The inventors are J. E. Ammann of Denver, and his brother, C. E. Ammann of Spokane, Wash.

To demonstrate, the brothers borrowed an old electric auto, took out the batteries, and after roping their new "atmospheric generator" fast, they got in and rode off at high speed.

balance bodies was the highlight of

"New C

Buys a brand new s
\$1,625.00 f. o. b. P
automobile. The fa
them to some other
cost of re-shipment
make special terms
cars. There are on

NEW 1

The same m
rather than re;sh
excellent satisfact
saving on a high-
pay you to buy an

\$2,500.00 truck cha
\$2,700.00 truck cha
curtains
\$3,000.00 truck cha
open express bod

All of the a
This offer w
few days only. If
given to ship them

"TWO REA

Dodge Coupe
car for private use
1921 Nash 7
extra equipment.
Special terms on a
Then we ha
Dodge Coupe
Ford Coupe
Hudson Sup
1921 Essex

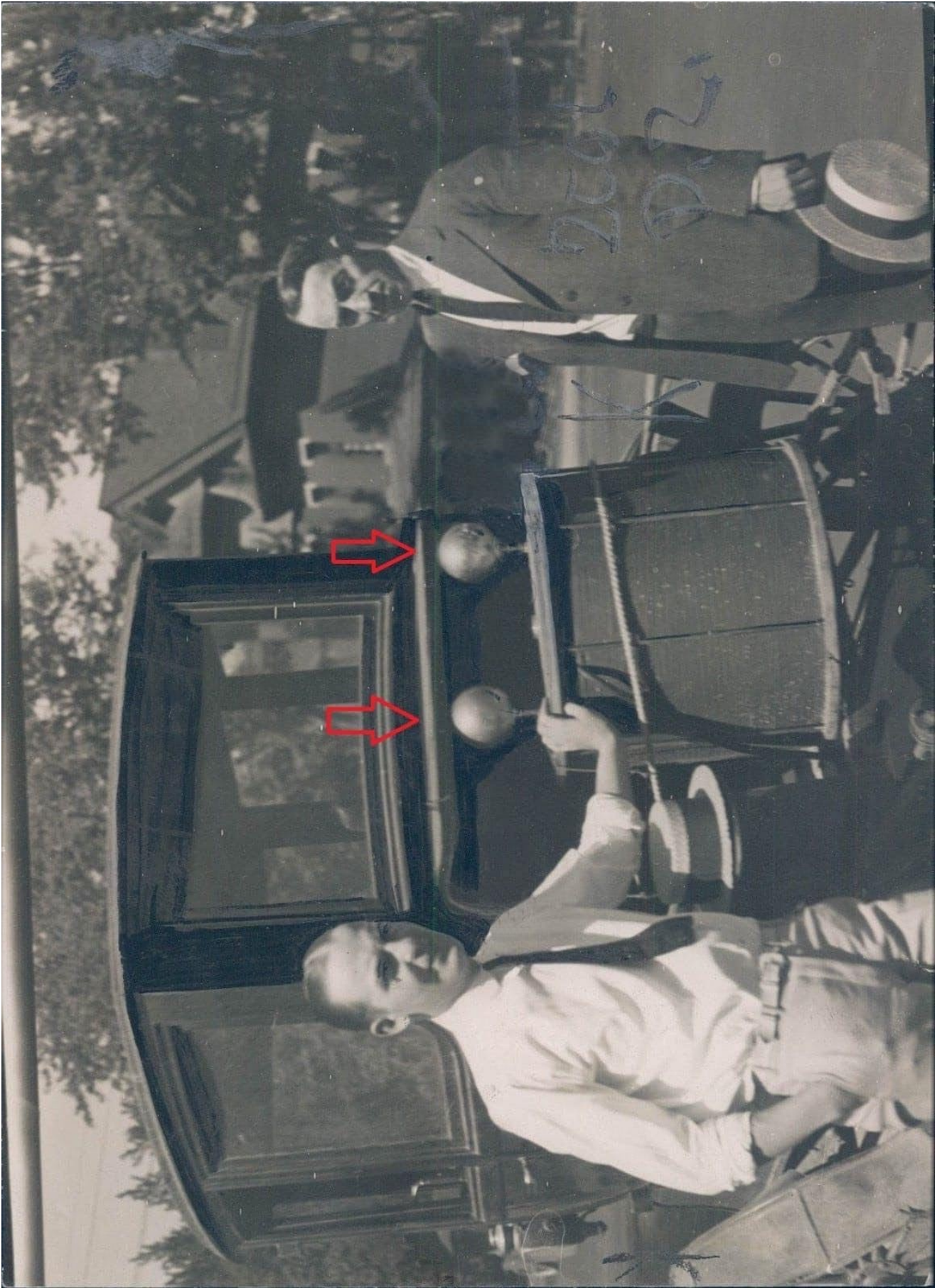

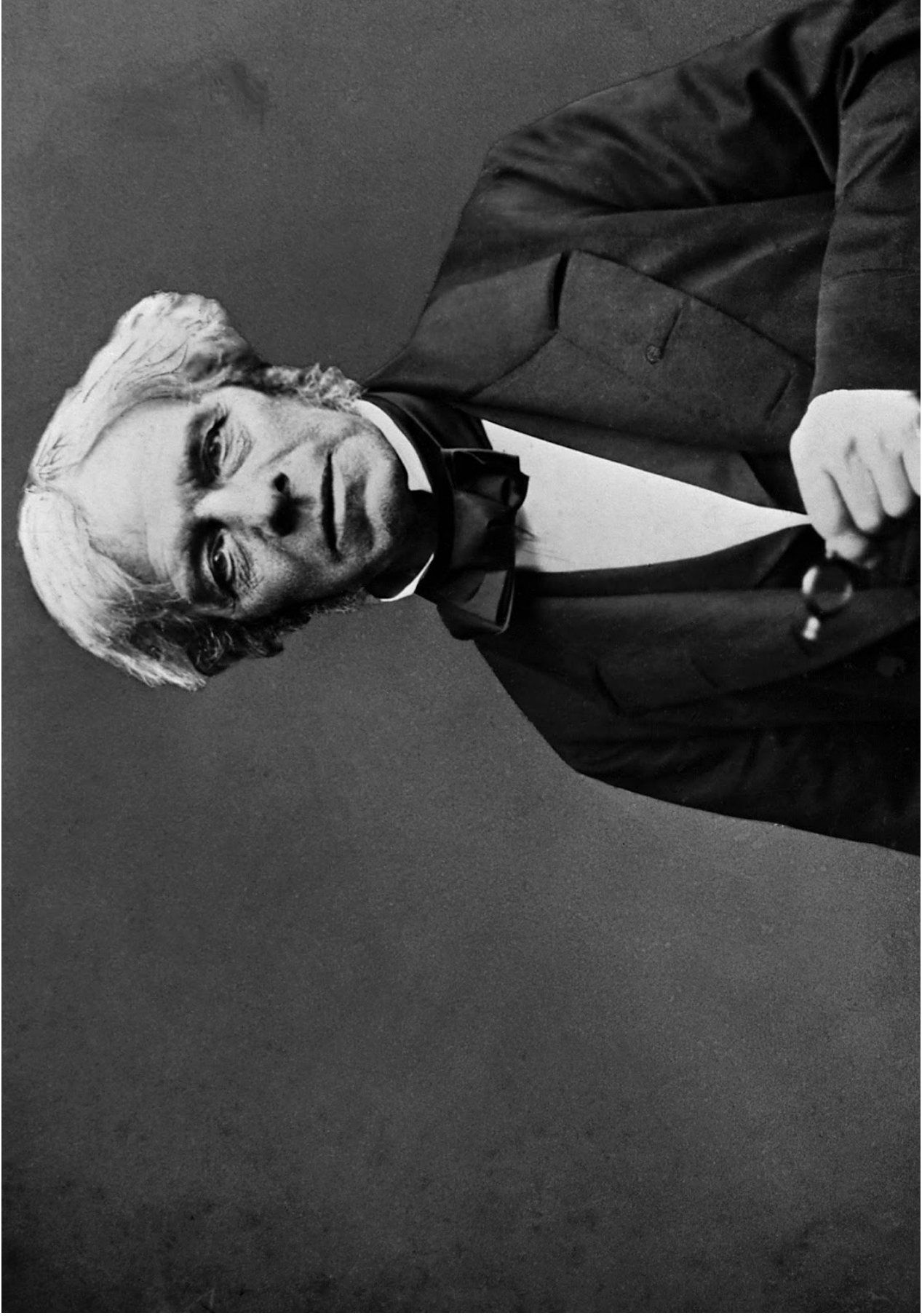

Michael Faraday

