

Nothing is too wonderful to be true if it be consistent with the laws of nature,

and in such things as these, experiment is the best test of such consistency.



Does Michael Faraday's Law of Induction concern itself with the conversion (consumption / conservation) of alternating (A/C) power or with the generation of alternating power?

I think it is the former. The latter condition of the synthesis (generation) of power is a standing wave which cannot dissipate, ie. it cannot exit the circuit as: heat, or light, or mechanical motion of a coil unless it is first converted. But for this conversion to occur, it can no longer exhibit a standing wave pattern in which its phase of voltage and its phase of current are diametrically opposed in polarity (with 180° of separation between them). Instead, in order for conversion to occur, it must realign the phase polarities of its voltage and current to exhibit a maximum power factor to manifest, and maximize, the output of this conversion of power. Otherwise, the standing wave pattern will force a constant build up of reactive power which will, eventually, destroy the circuit which hosts this condition.

Hence, Michael Faraday's Law of Induction is a narrow niche, for it merely defines the consumption of power while ignoring its generation.

Energy is always moving, ie. undergoing changes, but standing waves of energy do not move. Their energy moves, yet their wave pattern does not move.

It is only a moving wave pattern which can be conserved. Everybody is so focused on the conservation of energy while ignoring the non-conservation of their standing waves. For, it is their patterns, not their energy, which defines the consumption or the generation of power.

Here is the data in the format of screenshots of the simulation of a circuit in Micro-Cap – which is a flavor of Berkeley SPICE authored by Spectrum-Soft...

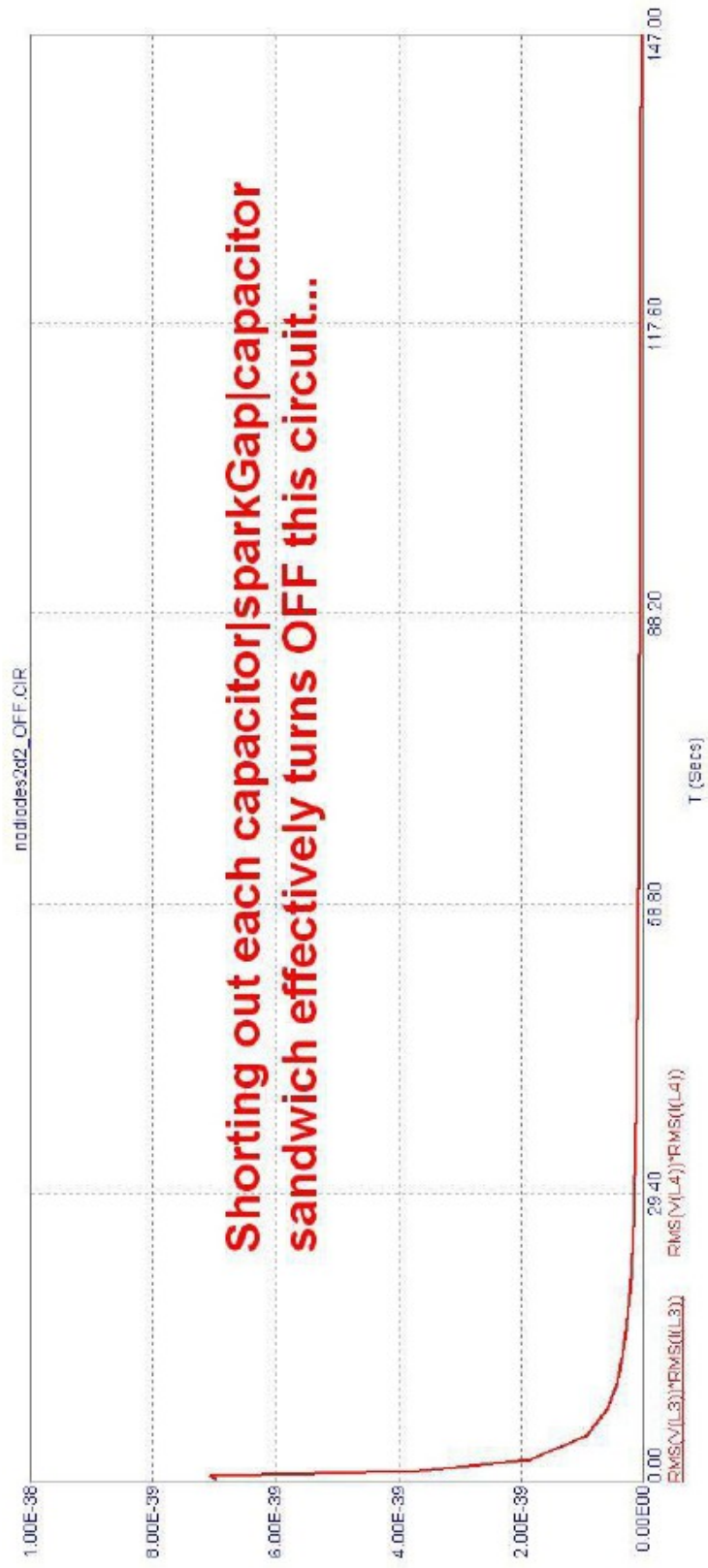

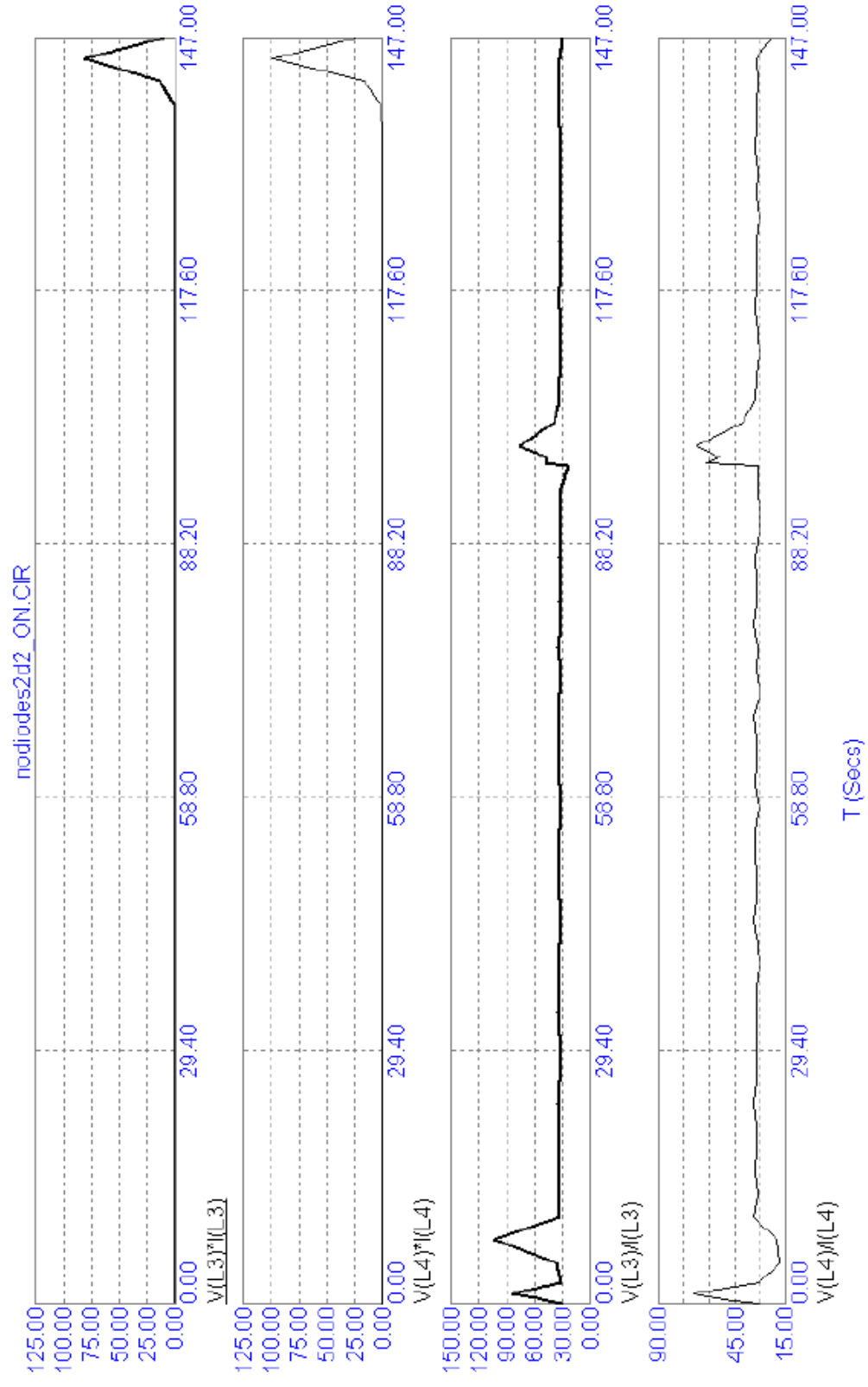

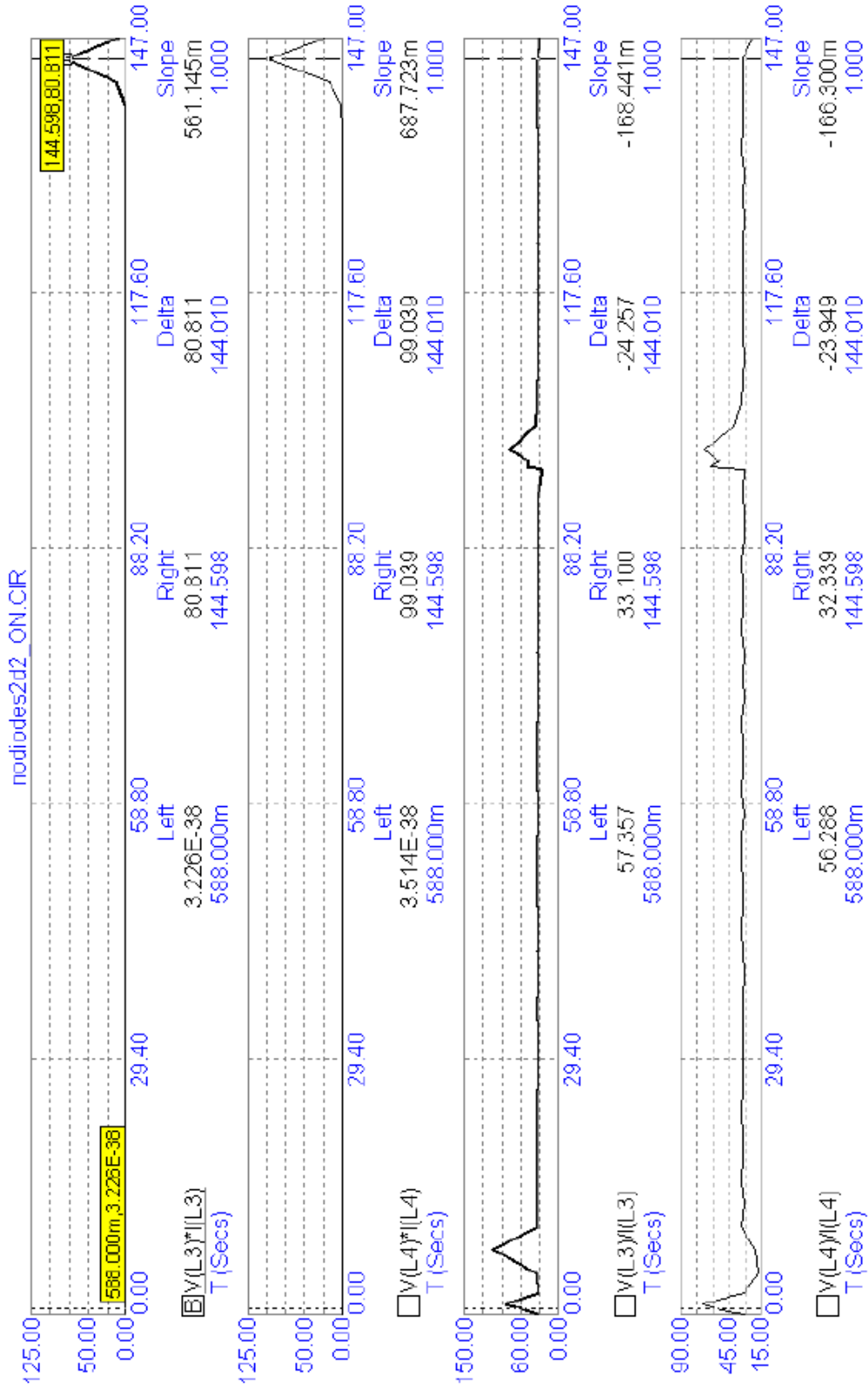

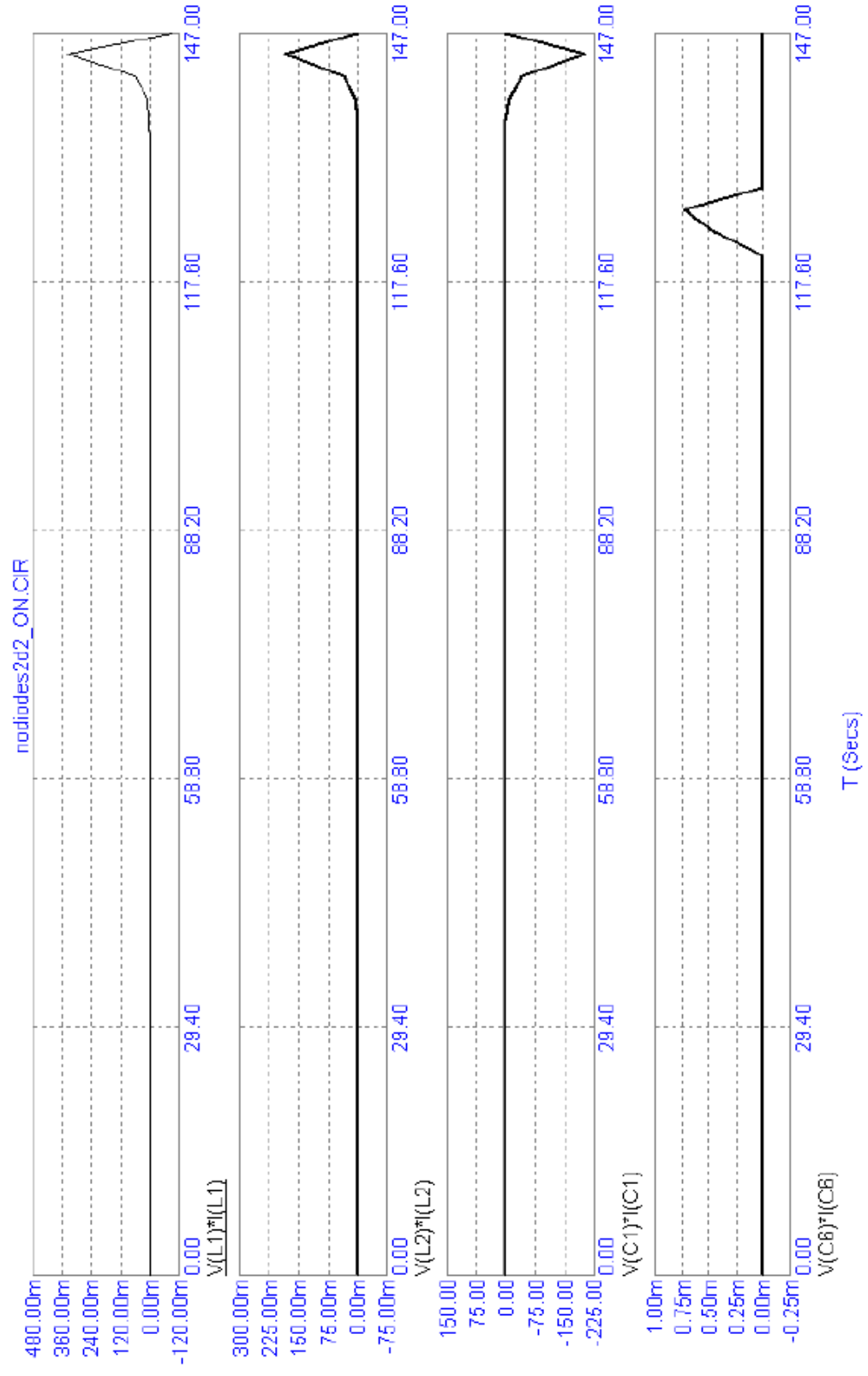

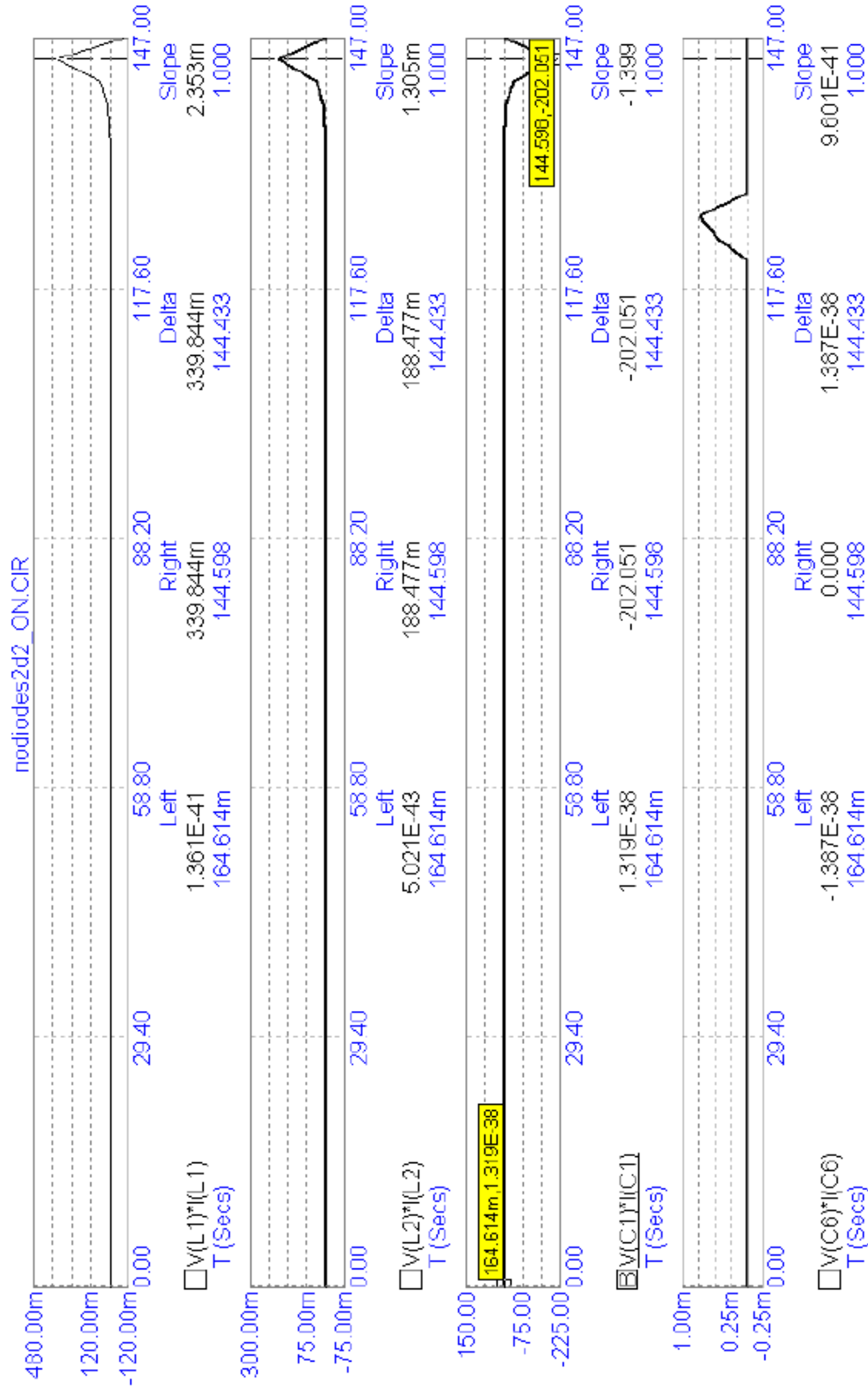

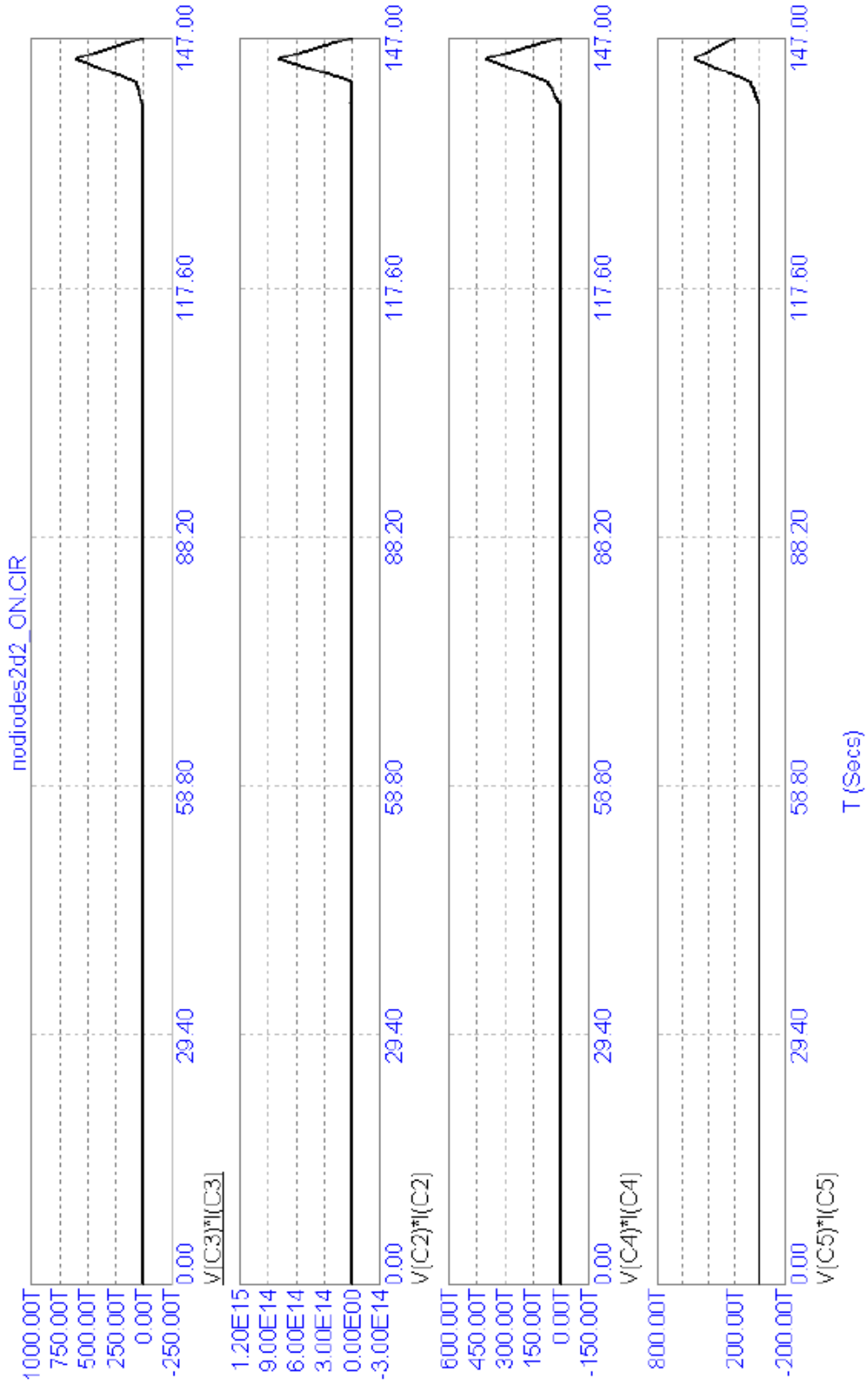

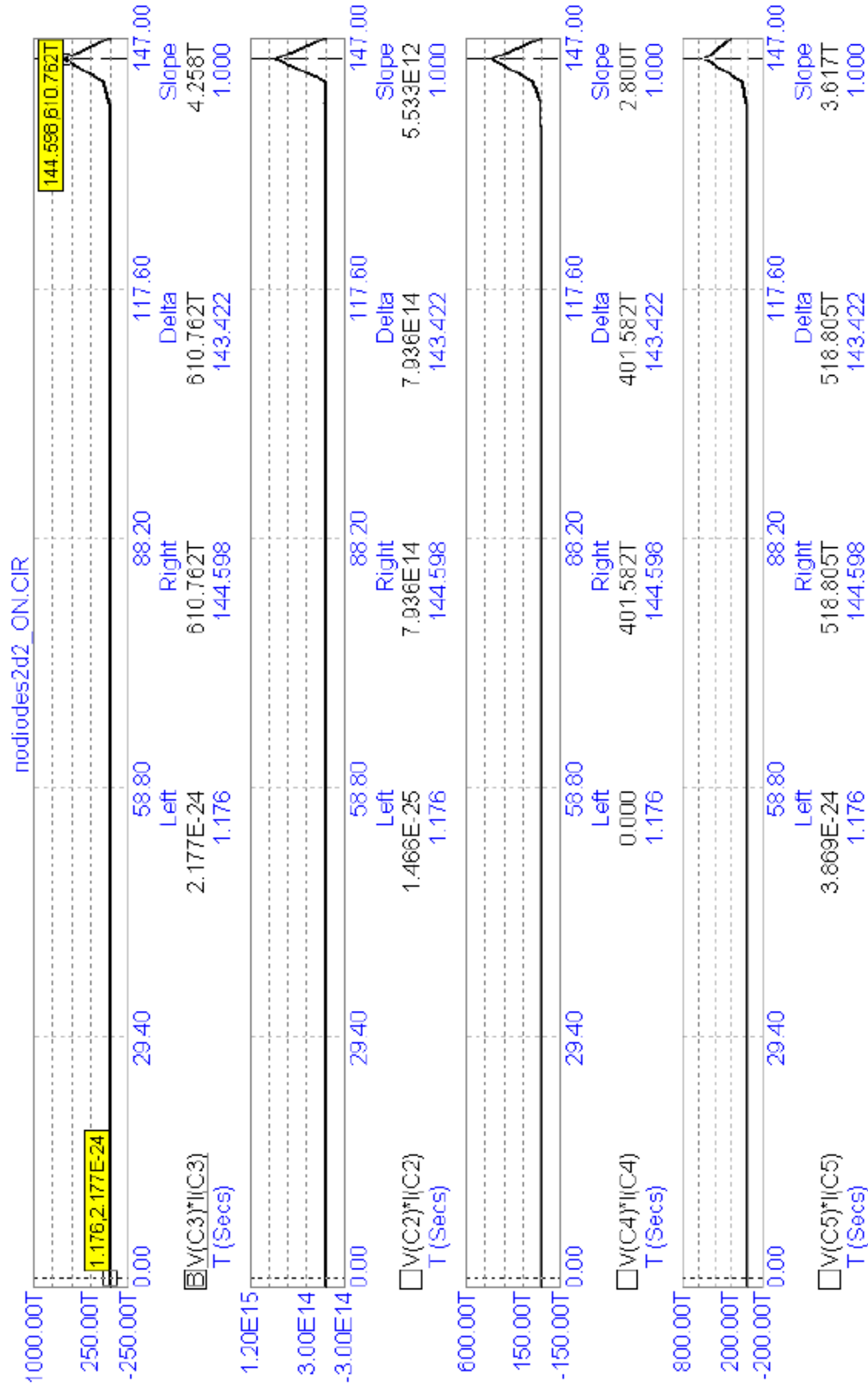

Nodal Voltages for X1 subcircuit, macro (Micro-Cap).

NEON BULB, SPARK GAP MACRO

.PARAMETERS(VTHRES=90, VARC=10, ISUS=500M,RNEG=-1,LPL=130N,RPL=2K,CPAR=1P,CARC=3P)

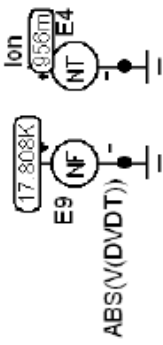
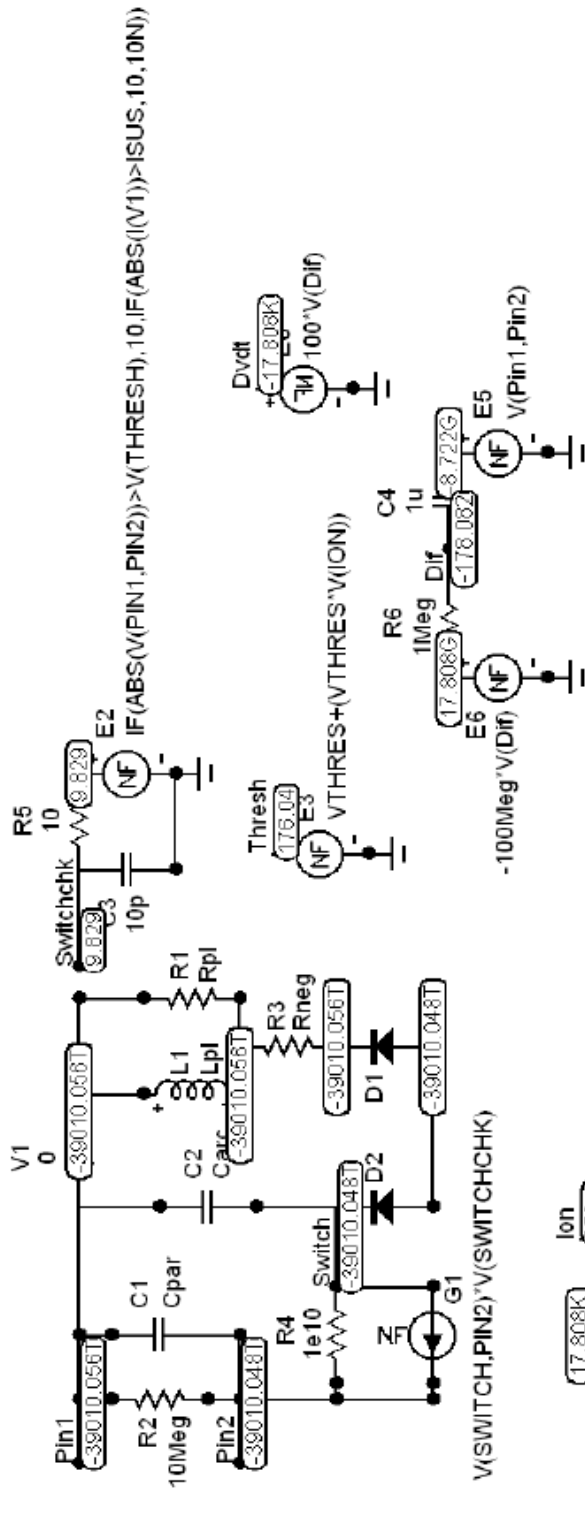

- .HELP VTHRES "Voltage at which the spark-gap strikes"
- .HELP VARC "Voltage across the spark-gap once struck"
- .HELP ISUS "Sustaining current under which the arc is stopped"
- .HELP RNEG "Negative resistance once struck"
- .HELP LPL "Lead/electrode inductance"
- .HELP RPL "Lead/electrode resistance"
- .HELP CPAR "Gap capacitance"
- .HELP CARC "Arc capacitance"

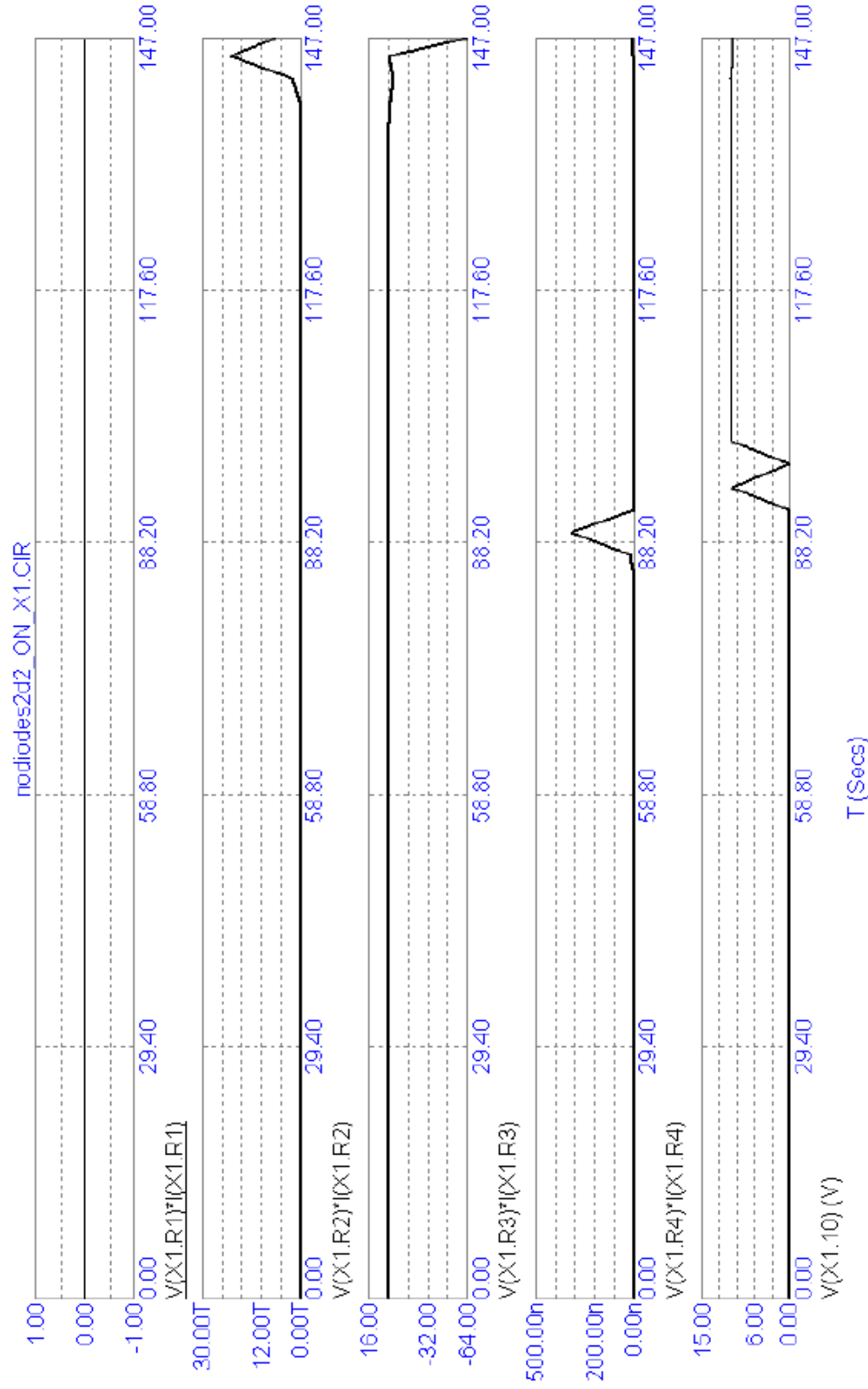

Node X1.10 tells us if this spark gap is ON if it equals ~10V. If ~10nV, then OFF. 14

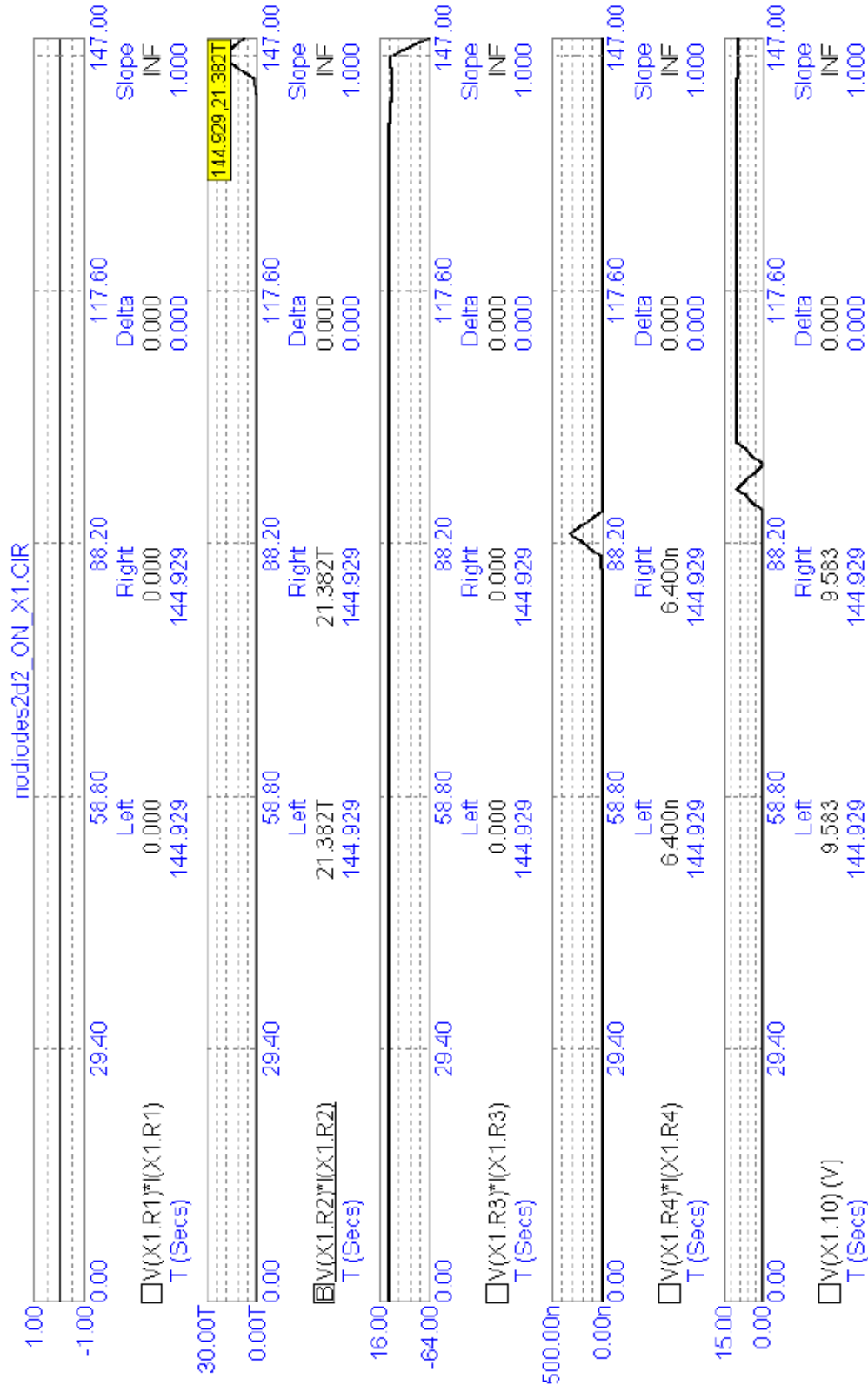

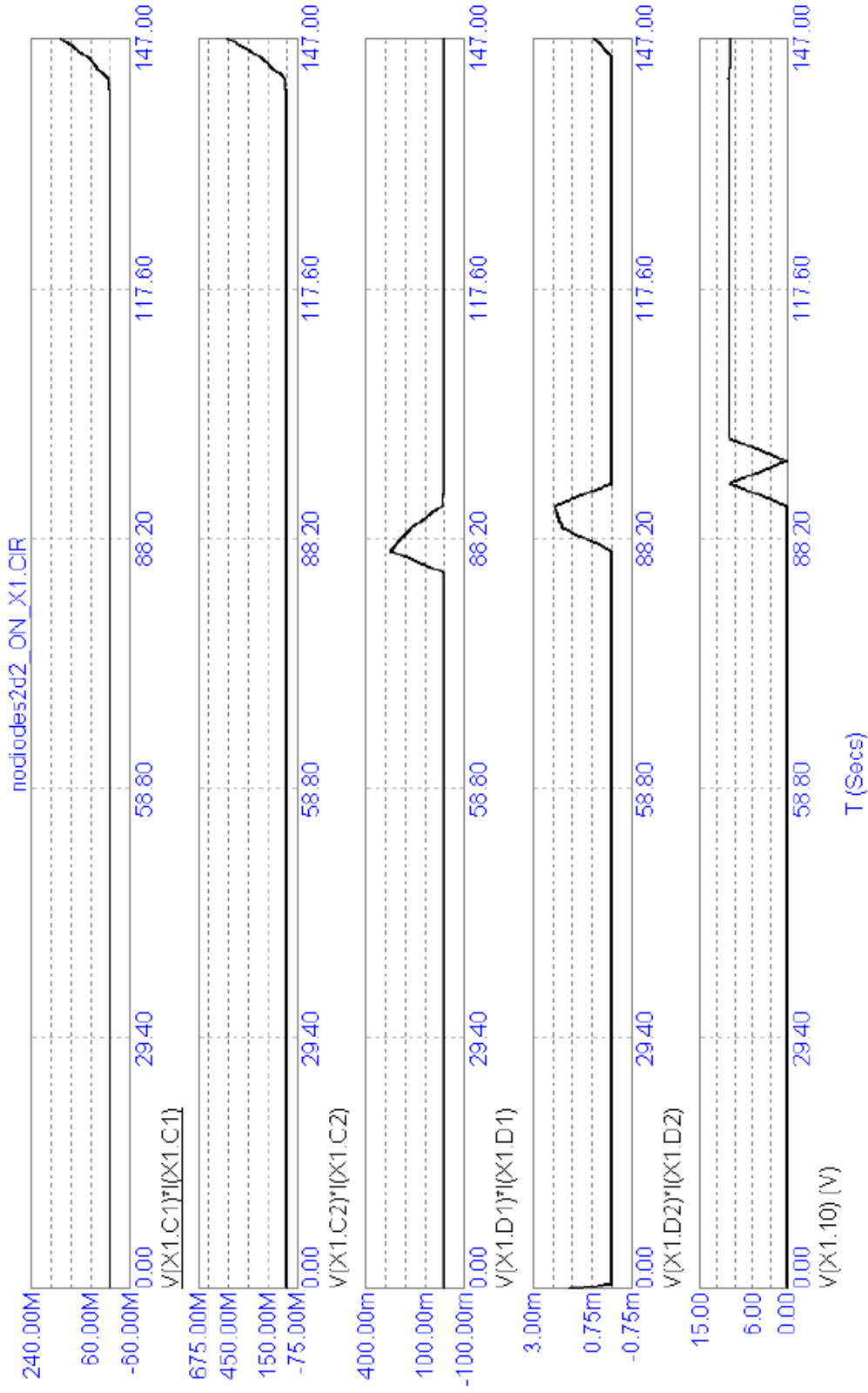

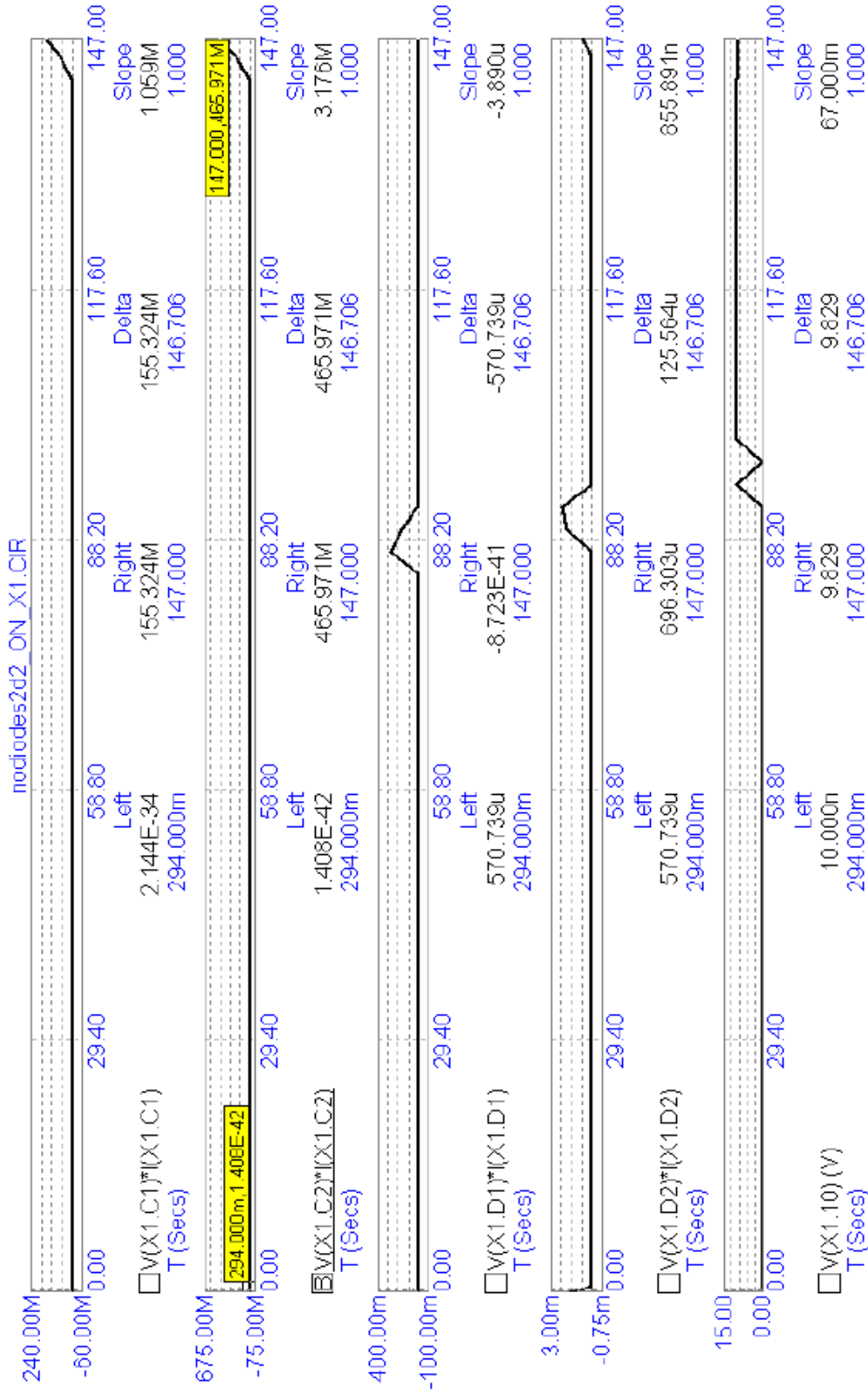

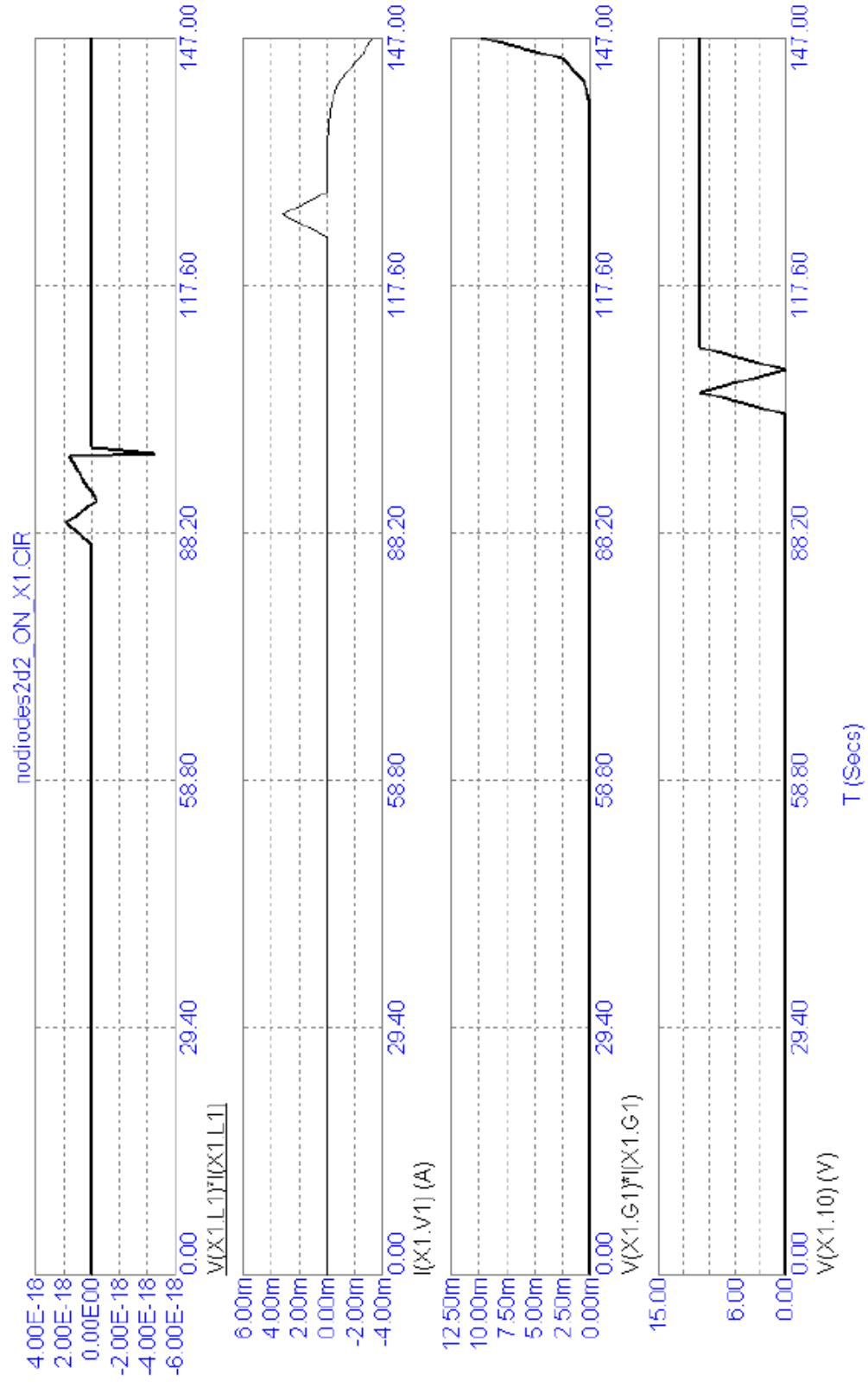

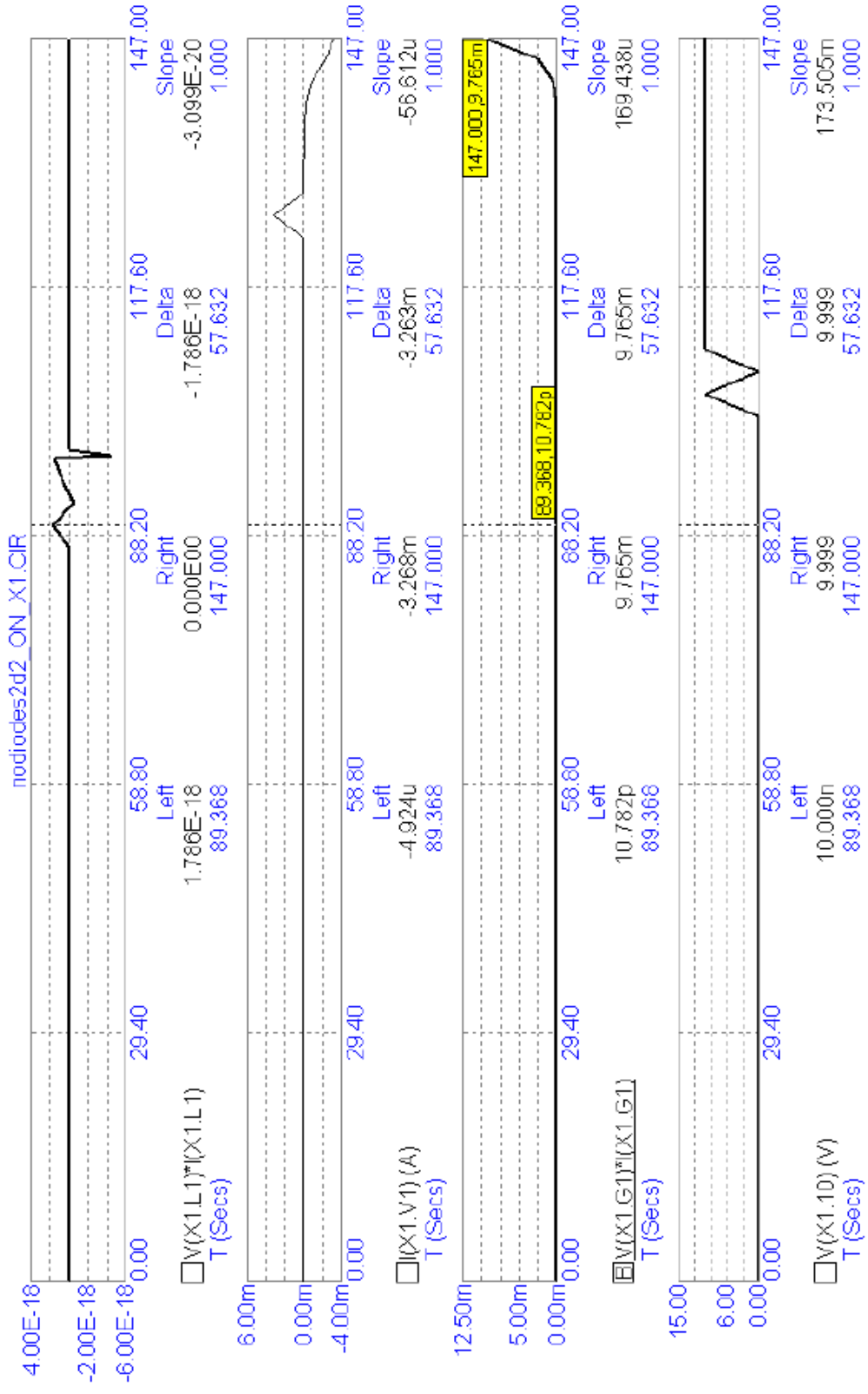

Nodal Voltages for X2 subcircuit, macro (Micro-Cap).

NEON BULB, SPARK GAP MACRO

.PARAMETERS(VTHRES=90, VARC=10, ISUS=500M,RNEG=-1,LPL=130N,RPL=2K,CPAR=1P,CARC=3P)

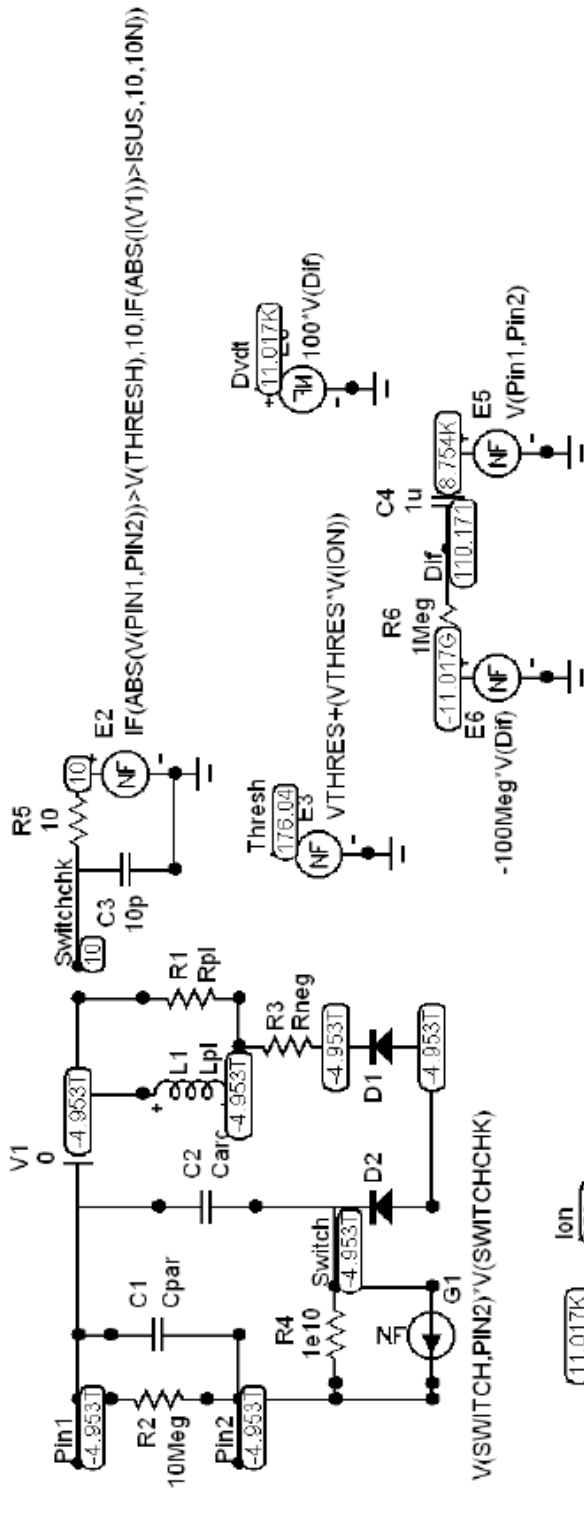

- .HELP VTHRES "Voltage at which the spark-gap strikes"
- .HELP VARC "Voltage across the spark-gap once struck"
- .HELP ISUS "Sustaining current under which the arc is stopped"
- .HELP RNEG "Negative resistance once struck"
- .HELP LPL "Lead/electro inductance"
- .HELP RPL "Lead/electro resistance"
- .HELP CPAR "Gap capacitance"
- .HELP CARC "Arc capacitance"

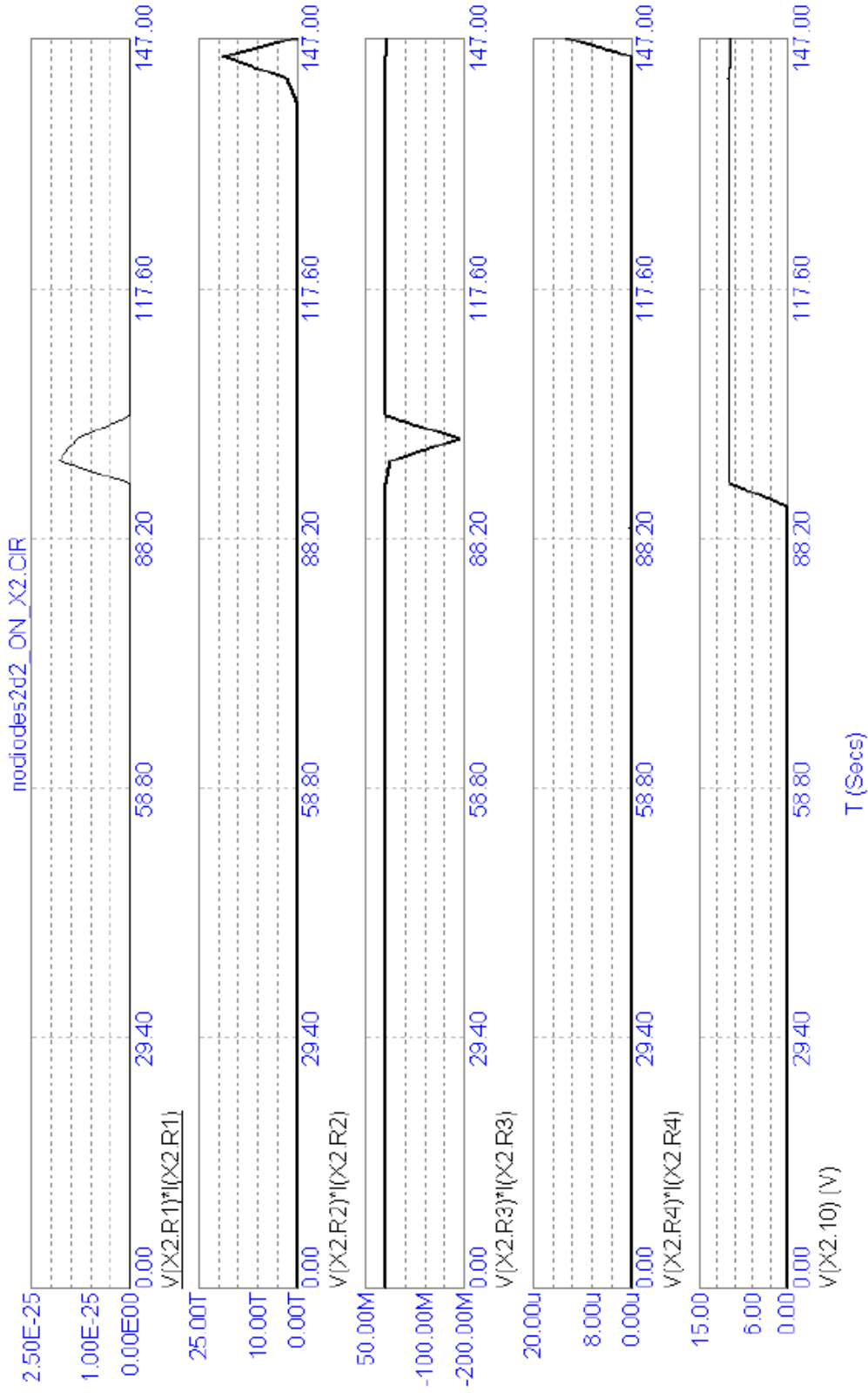

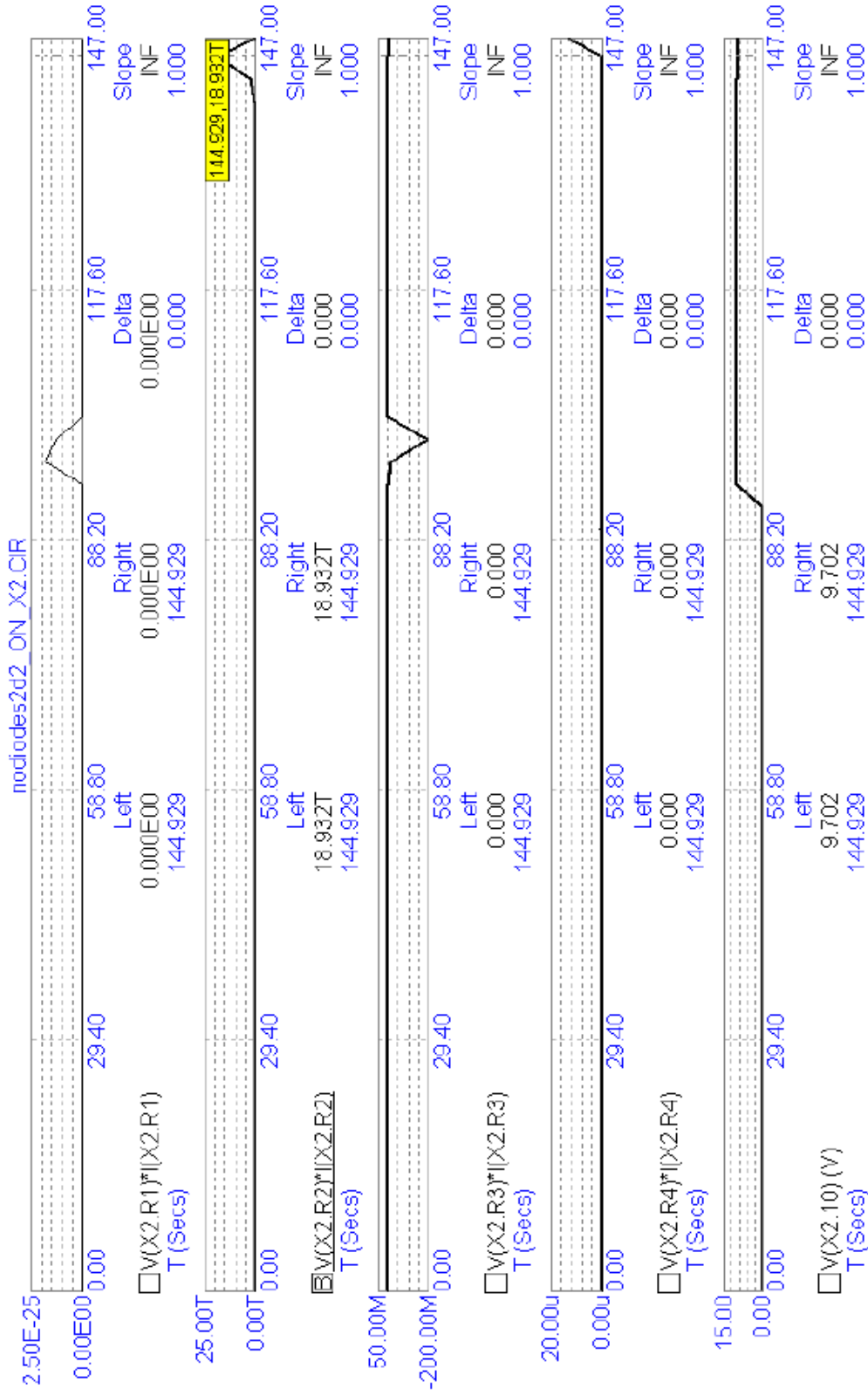

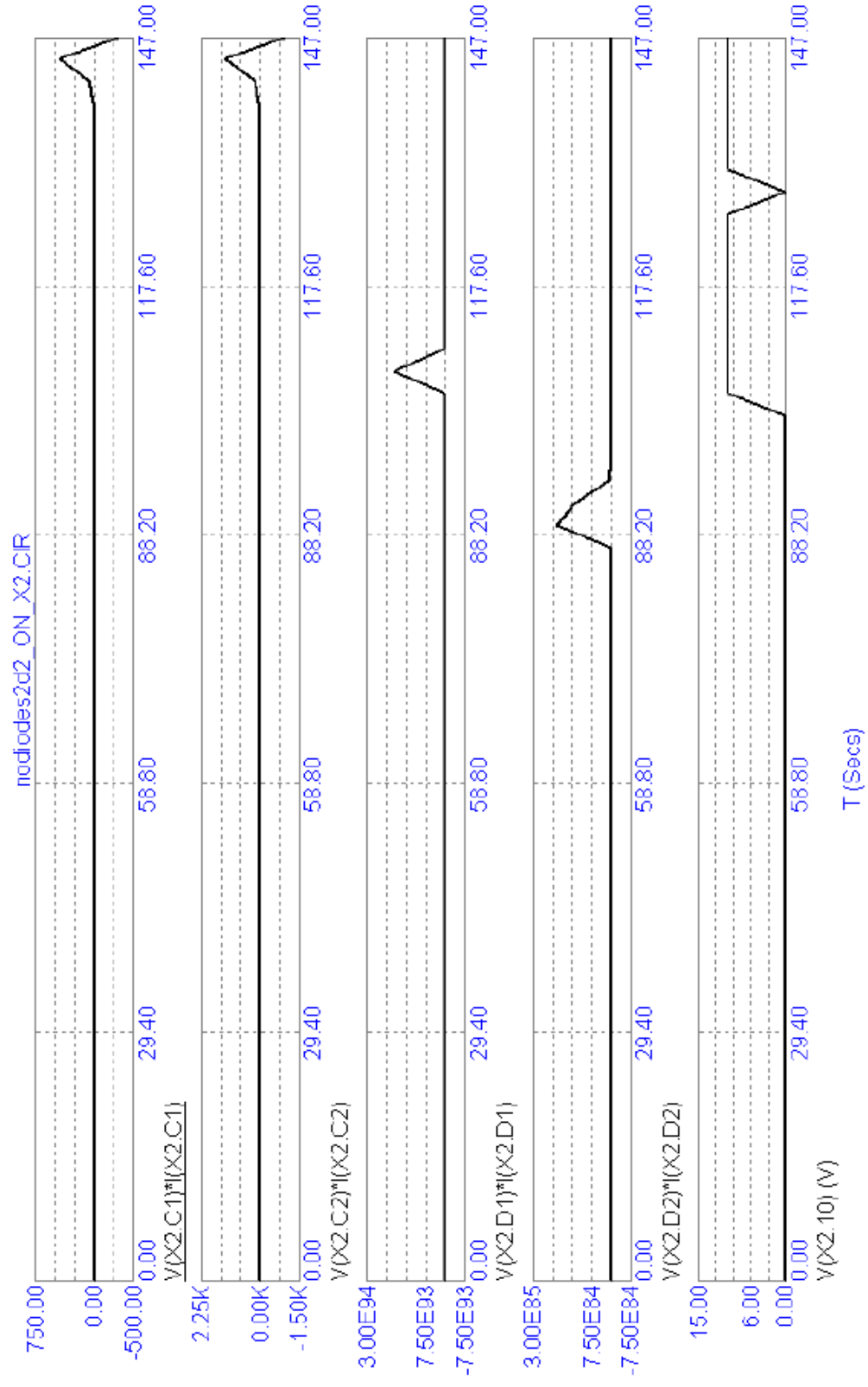

The following figures, FIG. 25 and FIG. 26, demonstrates how power is generated most of the time. Only occasionally does it react in the opposite (positive) direction to absorb, convert, and get rid of, this excess energy by spiking in the positive polarity once in a while.

So, causality has not been broken if we examine all of the components of a circuit over the entire duration of its run-time!

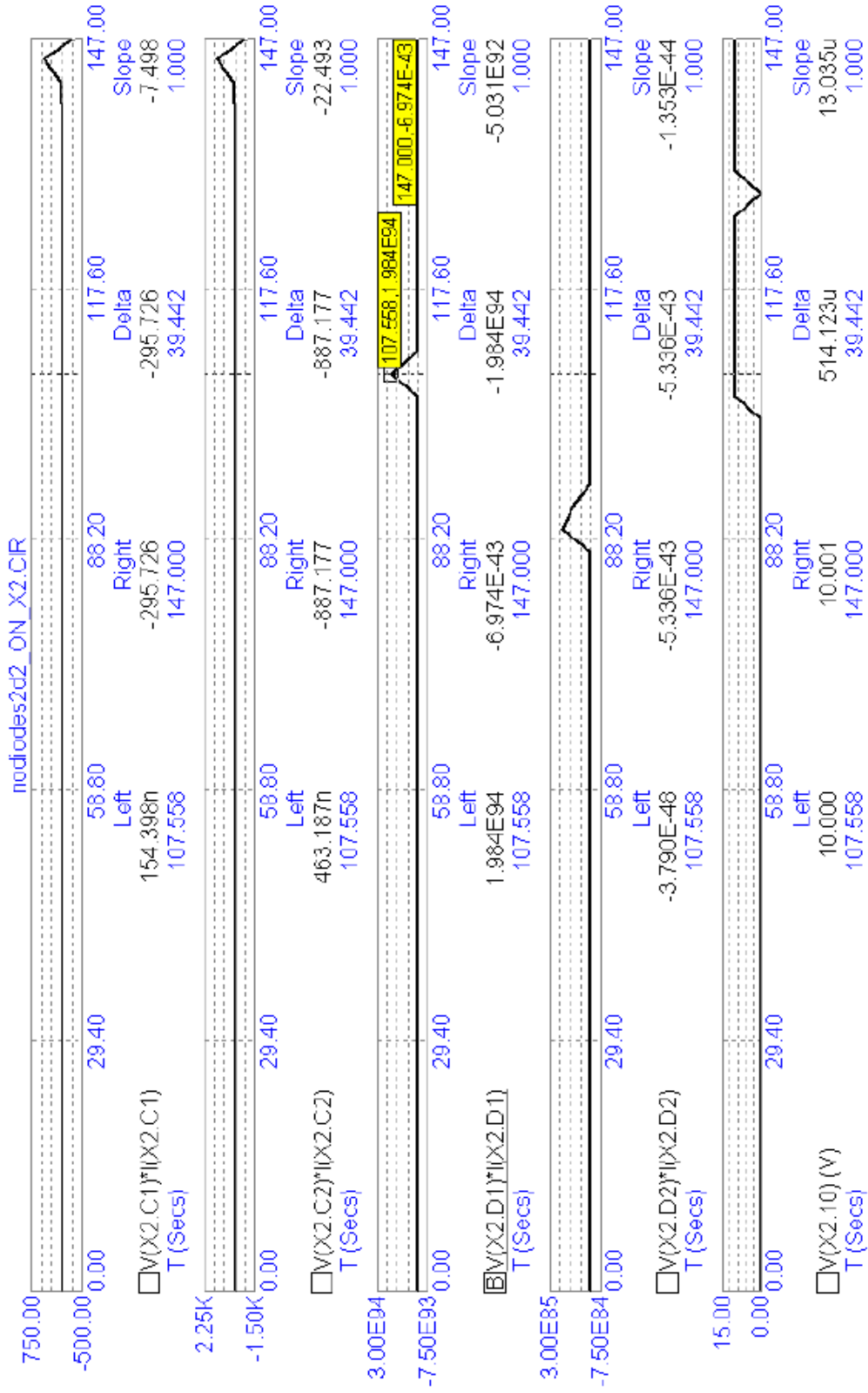

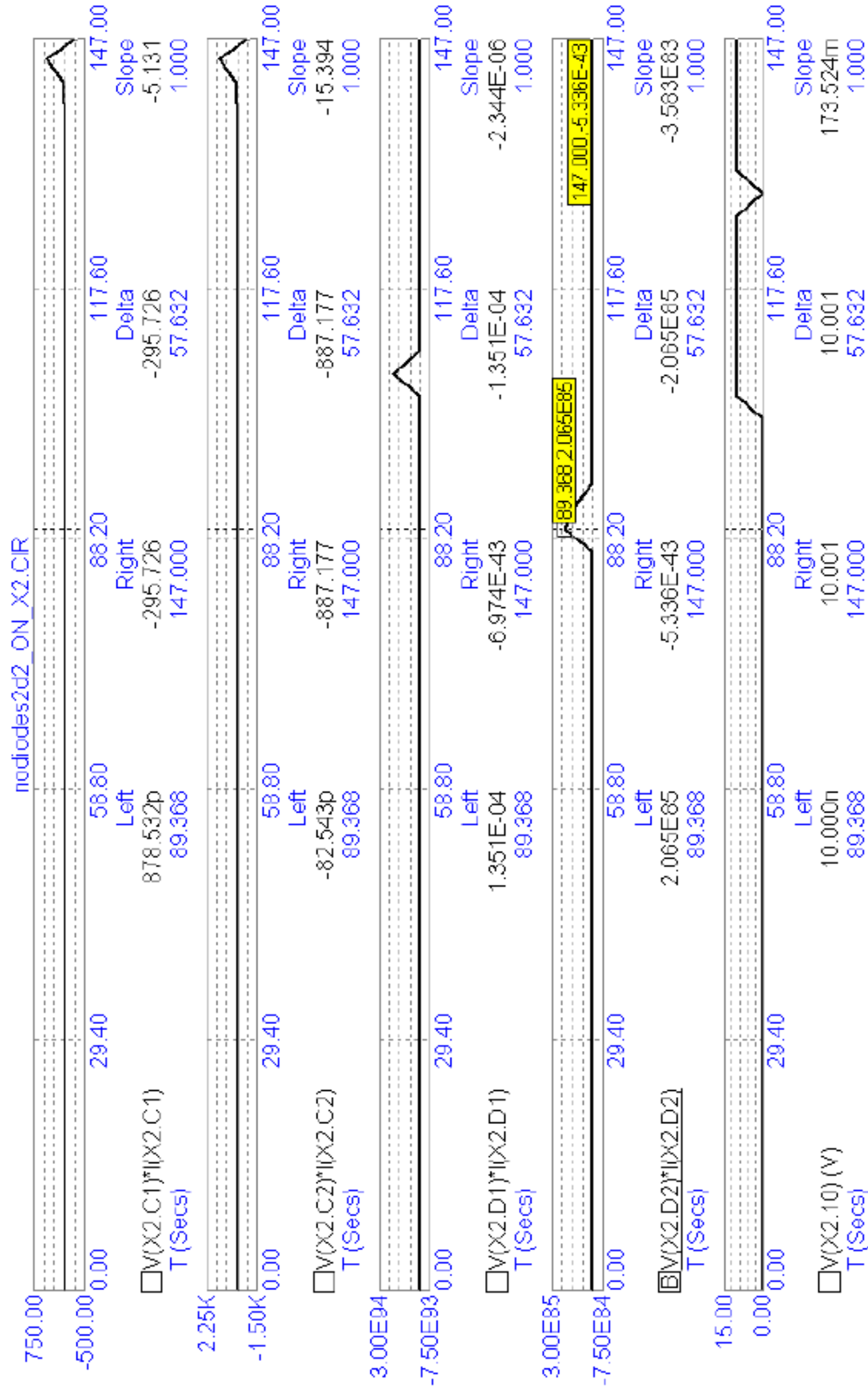

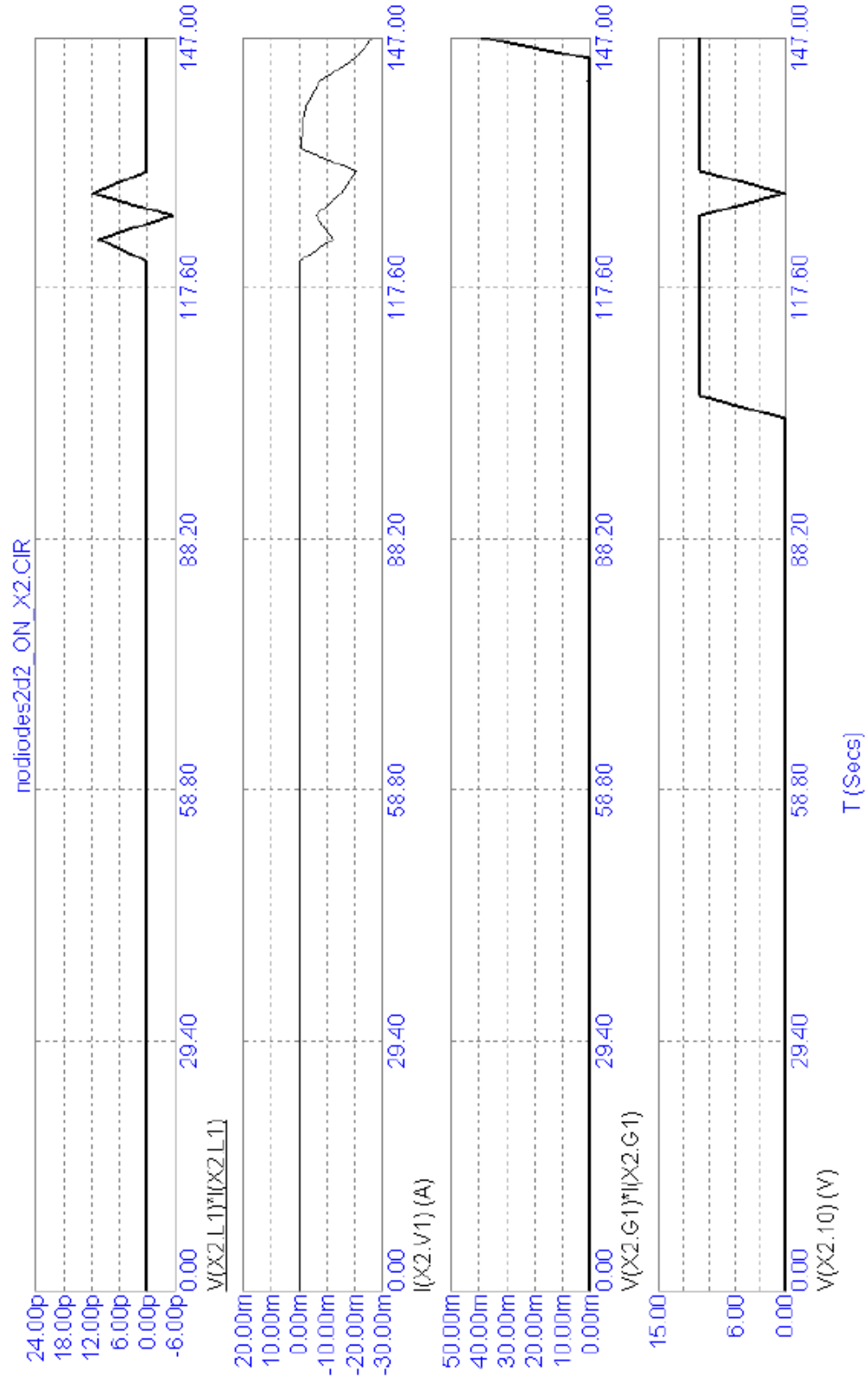

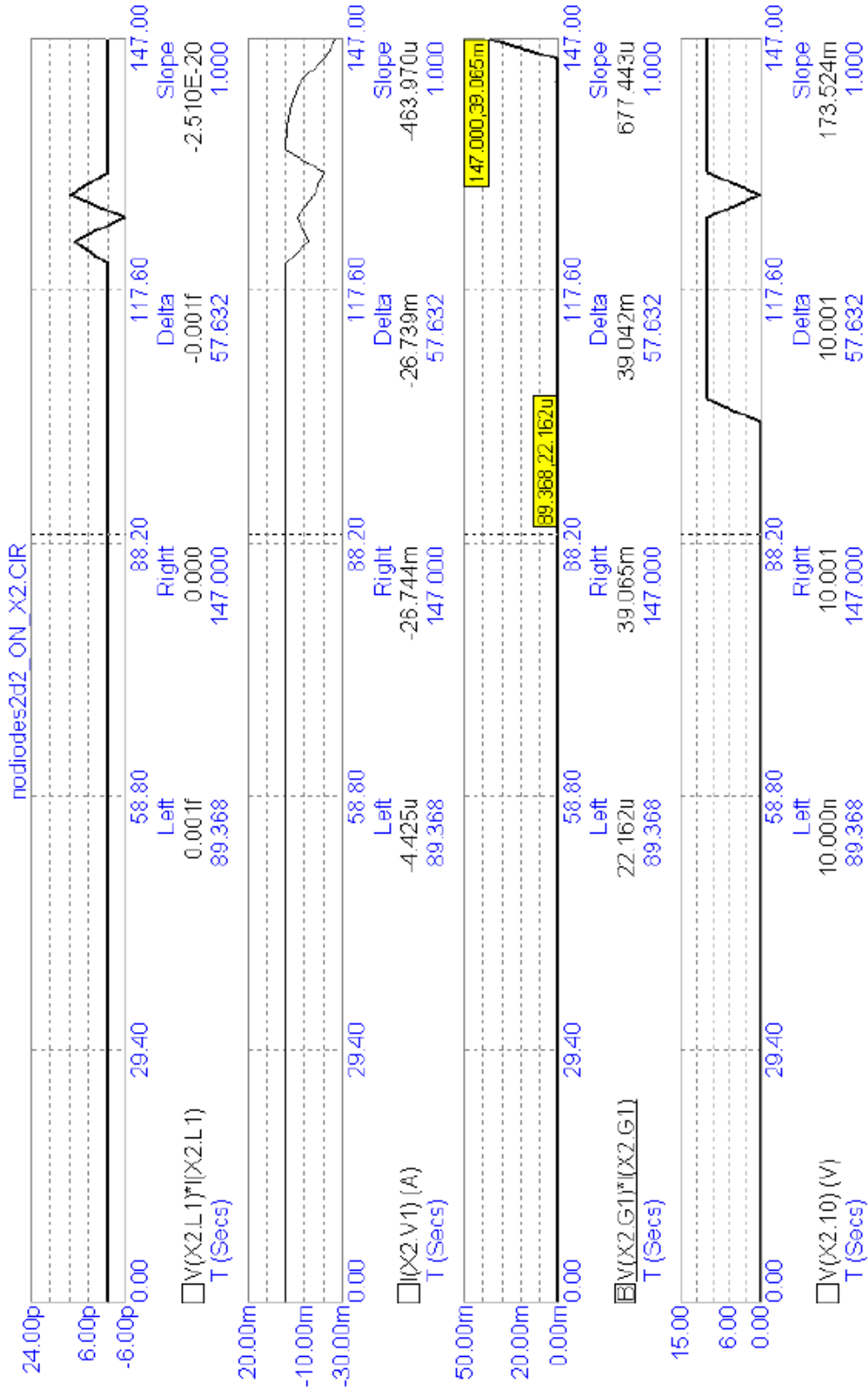

Why do we ignore “free energy?”

Because we are too preoccupied with energy while ignoring wave patterns.

The generation of energy is distinguished by a wave pattern called: a standing wave. These types of waves are rarely studied. They are the heart and soul of “free energy.”

A battery is an example of the conversion of the chemical energy which is stored inside of itself into electrical energy which exits its positive and negative terminals. Hence, it cannot generate energy; it merely converts energy from one format into another format.

The consumption of energy occurs whenever energy is being converted into another format, such as: electrical energy feeding a light bulb is converted into light and is distinguished by a wave pattern which moves. Hence, the battery and the light bulb inside of a flashlight circuit are not designed with the intention to generate power since that would give its owner a certain degree of freedom from having to purchase anymore power if he can generate his own power which he can't generate with a battery and a light bulb.

Yet, the arrangement of various electronic components (such as: capacitors and coils of wire, etc.) can sometimes generate power. And simple resistors, such as: heating elements, can convert the generation of this standing, electrical wave energy into useful heat energy and boil water to run a steam locomotive, or replace nuclear power at an electric power plant.

Energy always moves. Wave patterns move if they are merely consuming and converting power. Standing wave patterns do not move even though their energy is moving.

This is a very significant distinction we have been overlooking all this time arguing the pros and cons of free energy: is it a sham, or is it for real?

The theoretical evidence speaks for itself. Simulators are not the last word on this subject. Yet, they cannot be swept aside as rubbish, for that would deny their utilization by electrical engineers orchestrating the design for their new projects.

Hint...To interpret these slides requires looking at the polarity of sign for the value of each component. So, if a resistor possesses a negative sign out in front of its value for power, then this component is generating power and is a useless standing wave. On the other hand,

if a component possesses a positive polarity (indicated by the absence of any symbol for its sign), then that component is converting power into heat, or light, or the motion of a coil in an electric motor and must obey the laws of thermodynamics as they relate to conservation.

But the generation of power does not obey the law of the conservation of energy, because the generation of power is a standing wave. Its energy – inside of that wave pattern – conforms to the conservation of energy, but its standing wave pattern does not, because a pattern – in and of itself – is just a piece of information entertained by our mind. It does not exist in the concrete world of reality.

Yet we need these distinctions to help us to organize our thoughts on this subject.

So, from where does the extra energy come from whenever a standing wave clones itself? I don't know...

Some people have claimed that inventors who operate their “free energy” devices nearby any utility grid are stealing energy from that grid. That happened to C. Earl Ammann when he set foot within the jurisdiction of Washington, D.C., 100 years ago (in 1921) to deliver to the United States Patent Office his electric car powered by his invention devoid of the use of any batteries. He was promptly arrested before he could ever deliver his invention to the Patent Office on the grounds of his, “stealing energy from the grid.”

I think it was a bogus charge.

I think he was disrupting the utility grid located at the perimeter of his influence while supplying energy to the people located well within the diameter of his power supply's range of influence which was several miles mostly covering downtown Denver, Colorado, where he and his brother conducted their demonstration.

The following three images are relevant to my text. But Amazon altered their rules for publishing paperback books increasing the minimum number of pages from 24 to 72. So, I went online and gathered up 40 free clipart images to pad out my submission. I hope you don't mind...enjoy!

SUBSTANTIAL CUT IN PIERCE-ARROW PRICE ANNOUNCED

A substantial reduction in the prices of its touring car models effective after September 1, and a reduction on the prices of its truck models, effective immediately, has been announced by George W. Mixer, president of the Pierce-Arrow Motor Car company.

The new price of the standard seven-passenger touring car is \$6,500 at the factory, the enclosed car prices being graded proportionately.

The new prices of its truck models are: \$4,950 for the five-ton size; \$4,350 for the 3½-ton and \$3,200 for the 2-ton.

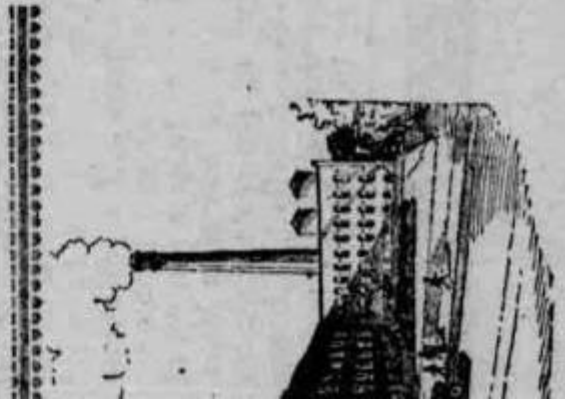

This Tire

ELECTRICITY "TAKEN FROM AIR" DRIVES AUTOMOBILE



C. E. AMMANN AND HIS "ATMOSPHERIC GENERATOR" ATTACHED TO AN ELECTRIC AUTOMOBILE

DENVER, Colo., Aug. 26.—Demonstrations are being made on the streets of Denver of a new electric generator that is claimed by the inventors to take electricity from the air.

The inventors are J. E. Ammann of Denver, and his brother, C. E. Ammann of Spokane, Wash.

To demonstrate, the brothers borrowed an old electric auto, took out the batteries, and after roping their new "atmospheric generator" fast, they got in and rode off at high speed.

"There is nothing inside the drum that moves; the contents consist only of iron, wire and minerals," says C. E. Ammann.

"It can be used to drive any electrical apparatus and can be made in any size."

The brothers are closely guarding their secret, and even take their "brain-child" when it is not in use, to their room in the Argonaut hotel.

So far the brothers have not offered to sell their proposition.

Electrical men in Denver are waiting "to be shown," but they grant the thing works.

balance bodies was the highlight of

"New C

Buys a brand new s \$1,625.00 f. o. b. P automobile. The fa them to some other cost of re-shipment make special terms cars. There are on

NEW 1

The same m rather than re;sh excellent satisfact saving on a high- pay you to buy an

\$2,500.00 truck cha
\$2,700.00 truck cha
\$3,000.00 truck cha
curtains
open express bod

All of the a This offer w few days only. If given to ship them

"TWO REA

Dodge Coupe car for private use 1921 Nash 7 extra equipment. covers and will m Special terms on Dodge Comr Ford Coupe Hudson Sup 1921 Essex

